

**2019/20
SPECIAL**

50 Years
bedrunka+hirth
Workplace up to date – mehr Raum zum Arbeiten

EXPRESS
72h

MADE
IN
GERMANY



**Mobile
Drawer cabinet**

Ref. No. 68.221AM
More information s. page 3



Standard colors

- Environment-friendly powder-coating, 2-tone-combinations without supplement
- Please, indicate the colour/colours in your order. When not indicated, we deliver the product in the standard color light grey (7035) and light blue (RAL 5012)

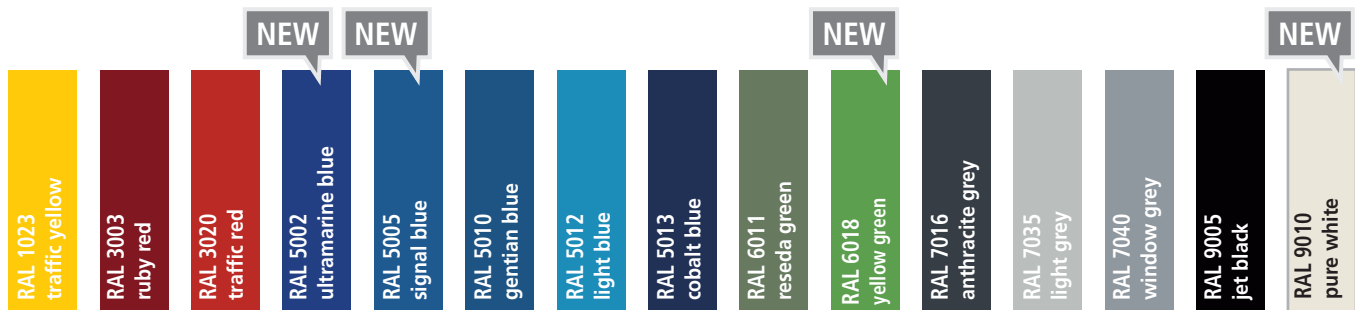

Drawer extension



All drawers fitted with full extension 100 %

- Depth 500 mm:
All drawers fitted with load capacity 50 kg
- Depth 736 mm:
Drawers with front height 50 mm -
load capacity 70 kg
- Drawers with front height 75 mm -
load capacity 100 kg
- Drawers with front height 300 mm -
load capacity 180 kg
- Ball bearing guides

Express 72 h



Express 72 h:

All products with this sign and in the colours RAL 7035/5012 can be despatched 3 days after order.

Certificate



TÜV-GS-certificate for all drawer cabinets in depth 736 mm

BEST OF SPECIAL

- Drawers with full pull-out 100%
- Drawers with front height 50 mm - load capacity 70 kg
- Drawers with front height 75 mm and more - load capacity 100 kg
- Drawer interior dimension: 600 x 600 mm
- Ball bearing guides
- Anti-tilt device

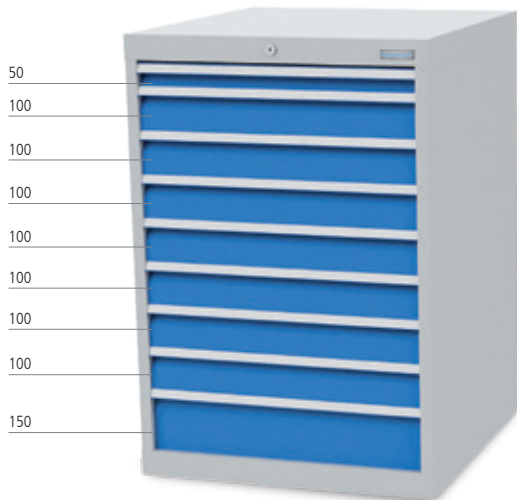

Drawer cabinet R 24-24

- 9 x drawers

EXPRESS
72h

Ref.no.	Dimensions (W x D x H) mm
700/1710V10A	705 x 736 x 1019

PRODUCT OF THE FRONT PAGE

50 Years

- Drawers with full pull-out 100%, load capacity 50 kg
- Drawer interior dimension: 600 x 400 mm
- Push handle
- Incl. roll-off edge on 3 sides
- Suitable divider material see page 27



Mobile Drawer cabinet R 24-16

- 5 x Drawers
- 4 x castor wheels Ø 125 mm, 2 x with locking device

Ref.no.	Dimensions (W x D x H) mm
68.221AM	680 x 500 x 990

- Drawers with full pull-out 100%, load capacity 100 kg
- Drawer interior dimension: 450 x 600 mm
- Beech multiplex worktop 40 mm

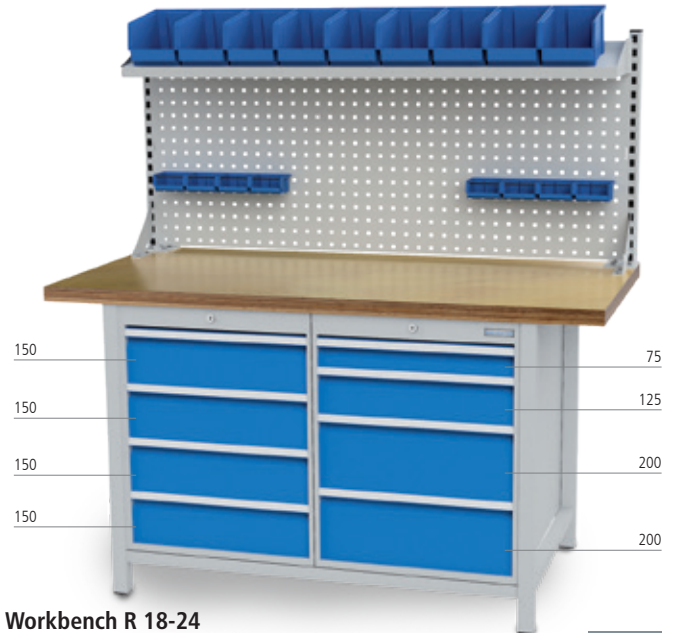

Workbench R 18-24

- Left: 4 x drawers | right: 4 x Drawers

Multi-Board

- 2 x Uprights 650 mm high, 2 x Perforated panels 1500 x 302 mm
- 1 x inclined shelf 1500 x 220 mm
- Range of hooks, 10 parts
- 17 x bins in different sizes

kg
1000

EXPRESS
72h

Ref.no.	Dimensions (W x D x H) mm
03.14.18VA	Workbench, 1500 x 750 x 859
03.14.18V9A	Workbench, 1500 x 750 x 959
03.900.15.18A	Multi-Board

- Drawers with full pull-out 100%, load capacity 100 kg
- Drawer interior dimension: 450 x 600 mm
- Ball bearing guides
- Anti-tilt device



Workbench R 18-24

- Beech multiplex worktop 40 mm
- 2 x drawers
- Shelf in half depth

Ref.no.	Dimensions (W x D x H) mm	Packaging Unit
03.14.32VA	1500 x 750 x 859	1 item
		2 item

Please, always indicate the colour/colours. Without indication we supply housing RAL 7035 light grey and fronts RAL 5012 light blue.

Drawer cabinets depth 736 | 705 x 736 x 819 mm (W x D x H) | R 24-24

- Drawers with full pull-out 100%
- Drawers with front height 50 mm - load capacity 70 kg
- Drawers with front height 75 mm and more - load capacity 100 kg
- Drawer interior dimension: 600 x 600 mm
- Ball bearing guides
- Anti-tilt device



Pallet truck plinth

- Steel sheet in front and rear screwed
- Including fixing material

EXPRESS
72h

Ref.no.	Dimensions (W x D x H) mm
01.070.012A	705 x 736 x 100

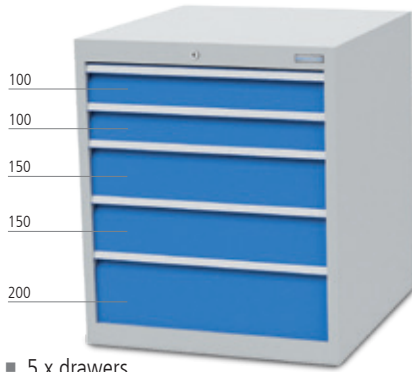

■ 5 x drawers

Ref.no.	780/0221V10A
---------	--------------

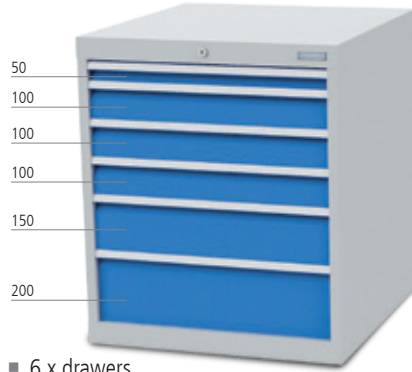

■ 6 x drawers

Ref.no.	780/1311V10A
---------	--------------

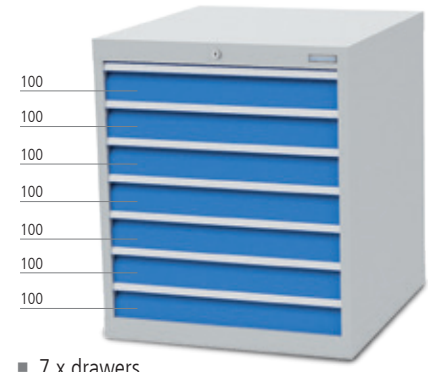

■ 7 x drawers

Ref.no.	780/0700V10A
---------	--------------

705 x 736 x 919 mm (W x D x H)

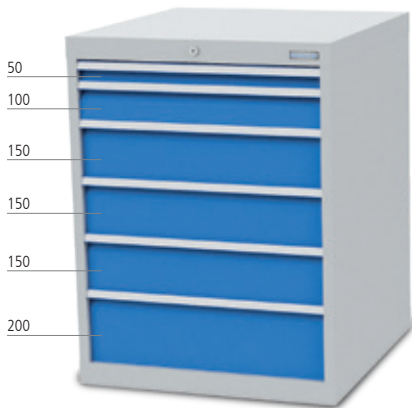

■ 6 x drawers

Ref.no.	790/1131V10A
---------	--------------



■ 8 x drawers

Ref.no.	790/0800V10A
---------	--------------

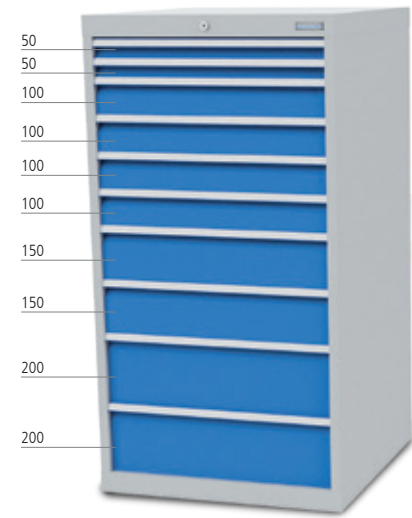

■ 10 x drawers

Ref.no.	713/2422V10A
---------	--------------

Accessories for interior dimensions 600 x 600 mm



Ribbed rubber inserts

- Front 50 mm and more

Ref.no.	140A
---------	------



Trough plates

- Front 50-75 mm

Ref.no.	130A
---------	------



Small parts boxes

- Front 75 - 100 mm

Ref.no.	132A
---------	------

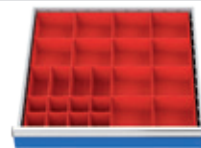

Small parts boxes

- Front 75 - 100 mm

Ref.no.	134A
---------	------



Metal dividers

- Front 100 mm

Ref.no.	139BLH100A
---------	------------

more dividing kits s. page 5 and 21

Drawer cabinets depth 736 | 705 x 736 x 1019 mm (W x D x H) | R 24-24

- Drawers with full pull-out 100%
- Drawers with front height 50 mm - load capacity 70 kg
- Drawers with front height 75 mm and more - load capacity 100 kg
- Drawer interior dimension: 600 x 600 mm
- Ball bearing guides
- Anti-tilt device

BESTSELLER



■ 6 x drawers

EXPRESS
72h

Ref.no.

700/1131V10A



■ 6 x drawers

EXPRESS
72h

Ref.no.

700/1122V10A



■ 7 x drawers

EXPRESS
72h

Ref.no.

700/1321V10A



■ 8 x drawers

EXPRESS
72h

Ref.no.

700/2321V10A

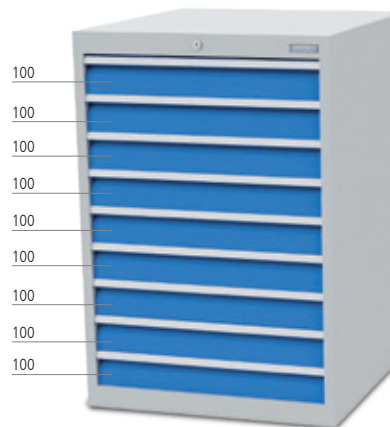

■ 9 x drawers

EXPRESS
72h

Ref.no.

700/0900V10A



■ 9 x drawers

EXPRESS
72h

Ref.no.

700/2223V10A

Accessories for interior dimensions 600 x 600 mm



Metal dividers

■ Front 100 mm

Ref.no.

138BLH100A



Metal dividers

■ Front 100 mm

Ref.no.

146BLH100A



Metal dividers

■ Front 150 mm

Ref.no.

139BLH150A



Metal dividers

■ Front 150

Ref.no.

144BLH150A



Metal dividers

■ Front 200 mm

Ref.no.

146BLH200A

more dividing kits s. page 4 and 21

Drawer cabinets depth 736 | 1005 x 736 x 1019 mm (W x D x H) | R 36-24

- Drawers with full pull-out 100%
- Drawers with front height 50 mm - load capacity 70 kg
- Drawers with front height 75 mm and more - load capacity 100 kg
- Drawer interior dimension: 900 x 600 mm
- Ball bearing guides
- Anti-tilt device

Pallet truck plinth

- Steel sheet in front and rear screwed
- Including fixing material



Ref.no.	Dimensions (W x D x H) mm
01.100.012A	1005 x 736 x 100

BESTSELLER



- 8 x drawers

Ref.no.
100/2321V10A

1005 x 736 x 1019 mm (W x D x H)



- 6 x drawers

Ref.no.
100/0222V10A

1005 x 736 x 1519 mm (W x D x H)

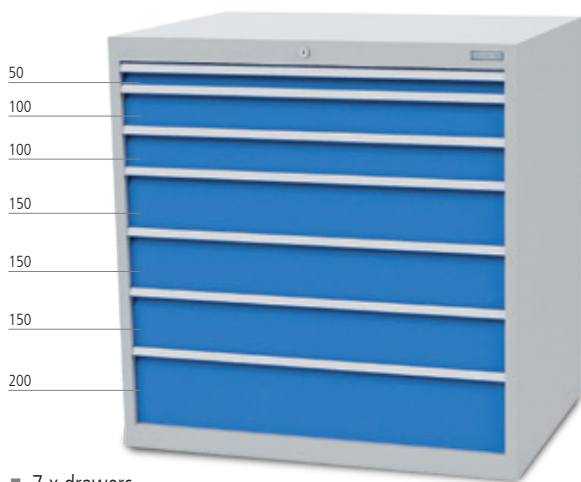

- 7 x drawers

Ref.no.
100/1231V10A

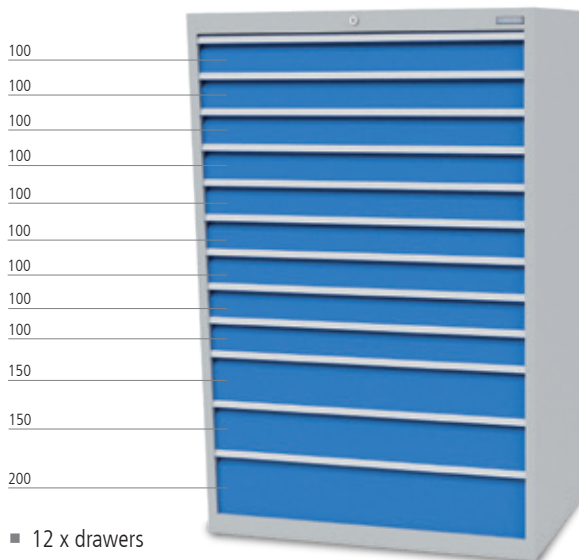

- 12 x drawers

Ref.no.
115/0921V10A

Accessories for interior dimensions 900 x 600 mm



Trough plates
■ Front 50 mm

Ref.no.
150A



Metal dividers
■ Front 100 mm

Ref.no.
153BLH100A



Metal dividers
■ Front 100 mm

Ref.no.
154BLH100A



Metal dividers
■ Front 150 mm

Ref.no.
153BLH150A



Metal dividers
■ Front 200 mm

Ref.no.
166BLH200A



Please, always indicate the colour/colours. Without indication we supply housing RAL 7035 light grey and fronts RAL 5012 light blue.

Pictures with housing in RAL 7035 and fronts RAL 3020.

Drawer cabinets depth 500 | 680 x 500 x 1019 mm (W x D x H) | R 24-16

- Drawers with full pull-out 100%, load capacity 50 kg
- Drawer interior dimension: 600 x 400 mm

BESTSELLER

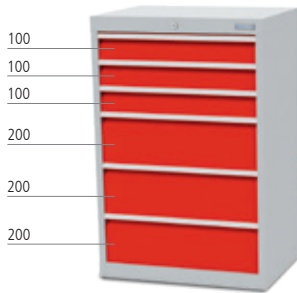

- 6 x drawers

Ref.no.
60.303A

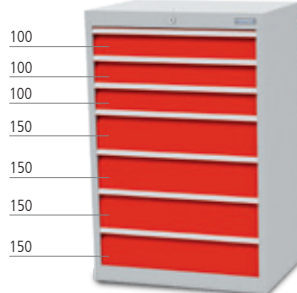

- 7 x drawers

Ref.no.
60.340A

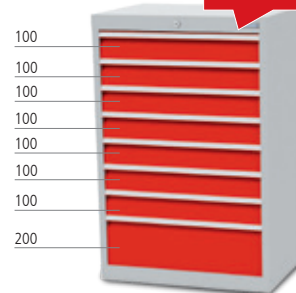

- 8 x drawers

Ref.no.
60.701A

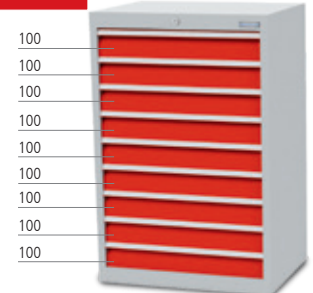

- 9 x drawers

Ref.no.
60.900A

Accessories for interior dimensions 600 x 400 mm



Ribbed rubber inserts

- Ab Front 75 mm

Ref.no.
65.068.530A



Small parts boxes

- Front 100 mm

Ref.no.
168-132A



Metal dividers

- Front 100 mm

Ref.no.
168-139A



Metal dividers

- Front 150 mm

Ref.no.
168-135A



Metal dividers

- Front 200 mm

Ref.no.
168-144A

Drawer cabinets depth 500 | 980 x 500 x 1019 mm (W x D x H) | R 36-16

- Drawers with full pull-out 100%, load capacity 50 kg
- Drawer interior dimension: 900 x 400 mm

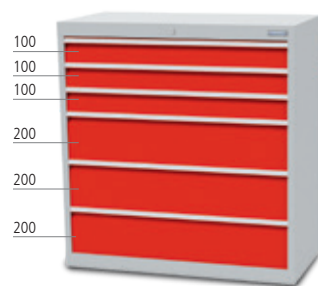

- 6 x drawers

Ref.no.
90.303A

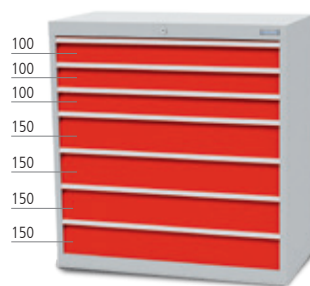

- 7 x drawers

Ref.no.
90.340A

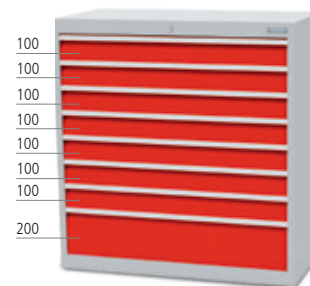

- 8 x drawers

Ref.no.
90.701A

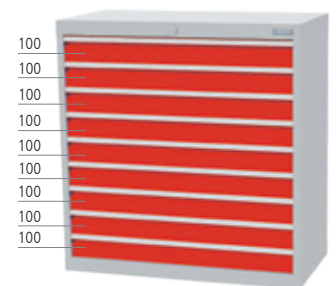

- 9 x drawers

Ref.no.
90.900A

Accessories for interior dimensions 900 x 400 mm



Ribbed rubber inserts

- Front 75 mm and more

Ref.no.
65.098.530A



Small parts boxes

- Front 100 mm

Ref.no.
198-132A



Metal dividers

- Front 100 mm

Ref.no.
198-139A



Metal dividers

- Front 150 mm

Ref.no.
198-136A



Metal dividers

- Front 200 mm

Ref.no.
198-144A

CNC-tool storing systems

CNC-Bench stands and CNC-Cabinets



Inserts

- This system is the most flexible available.
- The black plastic inserts are clipped into the heavy gauge steel tool carrier through a series of rebated slots.
- No fasteners are required to locate the inserts which can also be quickly removed by depressing the integral locking lug.

CNC E1		CNC E2		CNC E3	
SK 30		SK 40		SK 50	
VDI 25		VDI 40		VDI 50	
VDI 30		HSK A 50 / B 63		VDI 60	
MK3		HSK A 63 / B 80		HSK A 32 / B 40	
MK4		MK 5		HSK A 40 / B 50	
Capto C 4		Capto C 5		HSK A 80 / B 100	
				HSK A 100 / B 125	
				Universal	
				Capto C 3	
				Capto C 6	
				Capto C 8	

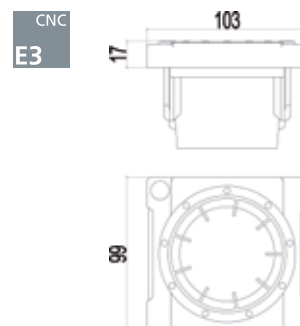
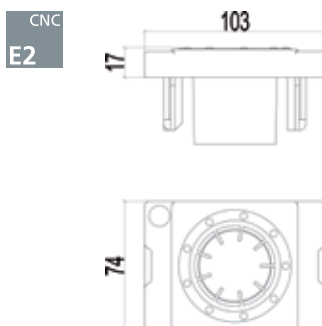
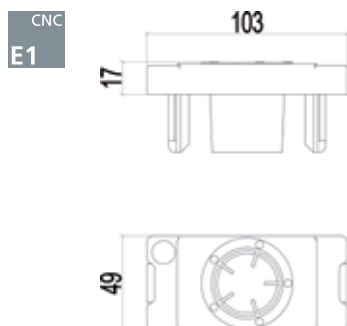

- 2 x or 4 x cassette, shelf, rubber mat and grips



CNC- Table rack attachment TAG 2

- with 2 floors incl. inserts

EXPRESS
72h

Ref.no.	Dimensions (W x D x H) mm	CNC E1	CNC E2	CNC E3
02.2210A	425 x 375 x 300	10/14*	10/10*	6/6*
02.2214A	575 x 375 x 300	14/20*	14/14*	8/10*



CNC- Table rack attachment TAG 4

- with 4 floors incl. inserts

EXPRESS
72h

Ref.no.	Dimensions (W x D x H) mm	CNC E1	CNC E2	CNC E3
02.2420A	425 x 375 x 525	20/28*	20/20*	12/12*
02.2428A	575 x 375 x 525	28/40*	28/28*	16/20*

* 1st figure: quantity of the inserts included type E1 or E2 or E3. 2nd figure: maximum of the inserts possible in the carrier of each type E1 or E2 or E3. Please, mention the tool inserts, without indication we supply ISO/SK 40. Delivery without tools.



02.2118.04/3A



02.289.00A

CNC-double swing doors T500 R 36-16

- 3 x CNC frames can be used inclined or flat
- 1 x shelf
- Incl. CNC-inserts

Ref.no.	Dimensions (W x D x H) mm	CNC E1	CNC E2	CNC E3
02.2118.04/3A	980 x 500 x 1838	66/144*	66/99*	45/72*

CNC-double swing doors T500 R 36-16

- 4 x CNC frames can be used inclined or flat
- Incl. CNC-inserts

Ref.no.	Dimensions (W x D x H) mm	CNC E1	CNC E2	CNC E3
02.2118.04A	980 x 500 x 1838	80/192*	80/132*	52/96*

CNC-roller shutter cabinet T500 R 36-16

- Aluminium-Roller
- 4 x CNC frames can be used inclined or flat
- Incl. CNC-inserts

Ref.no.	Dimensions (W x D x H) mm	CNC E1	CNC E2	CNC E3
02.289.00A	1000 x 500 x 1950	80/192*	80/132*	52/96*

CNC-roller shutter cabinet T500 R 36-16

- Aluminium-Roller
- 3 x CNC frames can be used inclined or flat
- 1 x shelf
- Incl. CNC-inserts

Ref.no.	Dimensions (W x D x H) mm	CNC E1	CNC E2	CNC E3
02.289.01/3A	1000 x 500 x 1950	66/144*	66/99*	45/72*



CNC-roller shutter cabinet T500 R 36-16

- Plastic Roller
- 4 x CNC frames can be used inclined or flat
- Incl. CNC-inserts

Ref.no.	Dimensions (W x D x H) mm	CNC E1	CNC E2	CNC E3
02.295.00A	1000 x 500 x 1950	80/192*	80/132*	52/96*



CNC-roller shutter cabinet T500 R 36-16

- Plastic Roller
- 3 x CNC frames can be used inclined or flat
- 1 x shelf
- Incl. CNC-inserts

Ref.no.	Dimensions (W x D x H) mm	CNC E1	CNC E2	CNC E3
02.295.01/3A	1000 x 500 x 1950	66/144*	66/99*	45/72*

* 1st figure: quantity of the inserts included type E1 or E2 or E3. 2nd figure: maximum of the inserts possible in the carrier of each type E1 or E2 or E3. Please, mention the tool inserts, without indication we supply ISO/SK 40. Delivery without tools.

CNC-tool storing systems

CNC-Transport systems

- Drawers with full pull-out 100%
- Drawers with front height 50 mm - load capacity 70 kg
- Drawers with front height 75 mm and more - load capacity 100 kg
- Drawers with front height 400 mm - load capacity 180 kg



CNC-Drawer cabinet T736 R 18-24 mobile

- 2 x fixed and 2 x swivel wheels ø125 mm. The swivel wheels with brake
- 1 x CNC-drawer frame 450 (SR)
- Incl. CNC-inserts
- Drawer interior dimension: 450 x 600 mm



Ref.no.	Dimensions (W x D x H) mm	CNC E1	CNC E2	CNC E3
02.2580.4RVB	555 x 736 x 971	25/35*	25/25*	15/15*

Optimal storage and transport



CNC-Trolley for tool carriers

- 2 x fixed and 2 x swivel wheels ø125 mm. The swivel wheels with brake
- Incl. 6 x CNC-Tol carrier 600
- The carriers at bottom can be ordered separately
- 1 x shelf at the bottom
- Incl. CNC-inserts



Ref.no.	Dimensions (W x D x H) mm	CNC E1	CNC E2	CNC E3
02.288.06A	630 x 900 x 860	42/60*	42/42*	25/30*



CNC-mobile cabinet

- 2 x fixed and 2 x swivel wheels ø125 mm. The swivel wheels with brake
- 6 x CNC-Tool carrier 600 or 900
- Incl. CNC-inserts

Ref.no.	Dimensions (W x D x H) mm	CNC E1	CNC E2	CNC E3
02.285.07A	560 x 630 x 950	30/60*	30/42*	20/30*
02.285.01A	560 x 930 x 950	48/96*	48/66*	34/48*

CNC-Shed

- Locking with cylinder lock

Ref.no.	Dimensions (W x D x H) mm	CNC E1	CNC E2	CNC E3
02.86.07A	705 x 736 x 1019	—	—	—
02.86.01A	705 x 1003 x 1019	—	—	—



CNC-Trolley

- 2 x fixed and 2 x swivel wheels ø125 mm. The swivel wheels with brake
- 4 x CNC-wide tool holders 900
- 4 x CNC-narrow tool holders 900
- 1 x top shelf
- Incl. CNC-inserts



Ref.no.	Dimensions (W x D x H) mm	CNC E1	CNC E2	CNC E3
02.58.44A	990 x 610 x 1450	84/192*	84/132*	64/96*

* 1st figure: quantity of the inserts included type E1 or E2 or E3. 2nd figure: maximum of the inserts possible in the carrier of each type E1 or E2 or E3. Please, mention the tool inserts, without indication we supply ISO/SK 40. Delivery without tools.

BESTSELLER

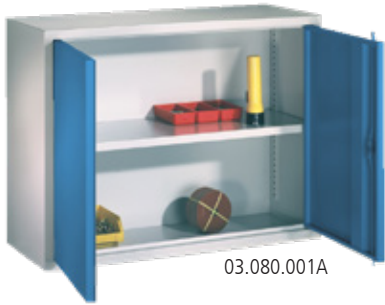

03.080.001A



03.040.091A



03.080.101A



03.040.191A

Wall hanging cabinet with door/doors

- with steel sheet in the rear
- 1 shelf

Ref.no.	Dimensions (W x D x H) mm	Version
03.040.091A	400 x 300 x 600	View window door
03.080.091A	800 x 300 x 600	View window doors
03.040.001A	400 x 300 x 600	Metal door
03.080.001A	800 x 300 x 600	Metal doors

Wall hanging cabinet with door/doors

- with perforated panel in the rear
- 1 shelf

Ref.no.	Dimensions (W x D x H) mm	Version
03.040.191A	400 x 300 x 600	View window door
03.080.191A	800 x 300 x 600	View window doors
03.040.101A	400 x 300 x 600	Metal door
03.080.101A	800 x 300 x 600	Metal doors

Workbenches

- Drawers with full pull-out 100%, load capacity 100 kg
- Beech multiplex worktop 40 mm



Workbench T736 R 18-24

- 1 x drawer, 1 x hinged door
- Drawer interior dimension: 450 x 600 mm

Ref.no.	Dimensions (W x D x H) mm
03.055.02VA	810 x 750 x 859
03.055.02V9A	810 x 750 x 959



Workbench T736 R 24-24

- 1 x drawer, 1 x hinged door
- Drawer interior dimension: 600 x 600 mm

Ref.no.	Dimensions (W x D x H) mm
03.075.02VA	810 x 750 x 859
03.075.02V9A	810 x 750 x 959



Workbench T736 R 24-24

- 4 x drawers
- Drawer interior dimension: 600 x 600 mm

Ref.no.	Dimensions (W x D x H) mm
03.075.04VA	810 x 750 x 859
03.075.04V9A	810 x 750 x 959

EXPRESS
72h

Accessories for interior dimensions 600 x 600 mm



Ribbed rubber inserts

- Front 50 mm and more

Ref.no.
140A



Metal dividers

- Front 150 mm

Ref.no.
135A



Small parts boxes

- Front 100-150 mm

Ref.no.
134A



Height adjustment

- Height-adjustable on a grid of 25 mm
- Complete for a workbench with 4 feet
- Only suitable for workbench height 859 mm

Ref.no.
03.15.95A

Workbenches and workstations

6-fold-workbench

- Drawers with full pull-out 100%, load capacity 100 kg
- Beech multiplex worktop 40 mm
- 6 x Drawer cabinet R 18-24 each 5 x Drawers
- Drawer interior dimension: 450 x 600 mm
- 6 x steel sheets
- Energy ramp separately see below



BESTSELLER



Drawer cabinet: 580/0221V10A

Ref.no.	Dimensions (W x D x H) mm
03.066.05V10A	2500 x 2165 x 859



6-fold energy ramp

- 2 sockets each working place
- Cover in beech multiplex

Ref.no.	Dimensions (W x D x H) mm
03.66.73-2A	822 x 712 x 162

Steel sheet (without single photo)

- To cover the space between the cabinets

Ref.no.	Dimensions (W x D x H) mm
03.58.20A	

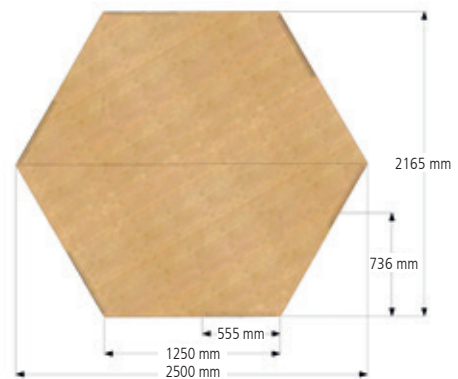

6-fold worktop

- Beech multiplex, delivery in 2 parts with connection
- Length each working place 1250 mm

Ref.no.	Dimensions (W x D x H) mm
03.15.66A	2500 x 2165 x 40

Drawer cabinets depht 736 | 555 x 736 x 819 mm (W x D x H) | R 18-24

- Drawers with full pull-out 100%
- Drawers with front height 50 mm - load capacity 70 kg
- Drawers with front height 75 mm and more - load capacity 100 kg
- Drawer interior dimension: 450 x 600 mm
- Ball bearing guides
- Anti-tilt device



- 4 x drawers

Ref.no.
580/1111VB



- 7 x drawers

Ref.no.
580/0700V10A



- with 2 separate locking systems
- Each 3 x drawers

Ref.no.
580/2.600V10A

BESTSELLER



- 6 x drawers

Ref.no.w
580/1311V10A

**EXPRESS
72h**



- 5 x drawers

Ref.no.
580/0221V10A

**EXPRESS
72h**



- 6 x drawers

Ref.no.
580/2121V10A

Accessories for interior dimensions 450 x 600 mm

More dividing s. page 18 and 19

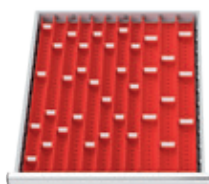

Trough plates

- Front 50-75 mm

Ref.no.
111A

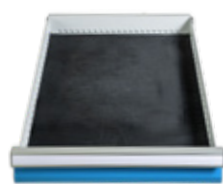

Ribbed rubber inserts

- Front 50 mm and more

Ref.no.
120A

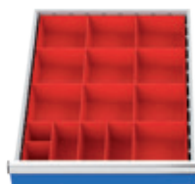

Small parts boxes

- Front 100 mm

Ref.no.
119A

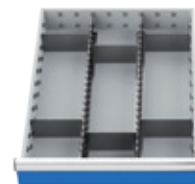

Metal dividers

- Front 150 mm

Ref.no.
113A



Metal dividers

- Front 200 mm

Ref.no.
118A

Workbenches and workstations

Reihenwerkbenke

- Drawers with full pull-out 100%
- Drawers with front height 50 mm - load capacity 70 kg
Drawers with front height 75 mm and more - load capacity 100 kg
- Drawer interior dimension: 450/600 x 600 mm
- Drawer block not lockable, Supplement for cylinder lock see table down
- Drawer cabinet with cylinder lock and 2 x keys
- Modular workbenches: Delivered unassembled

EXPRESS
72h*

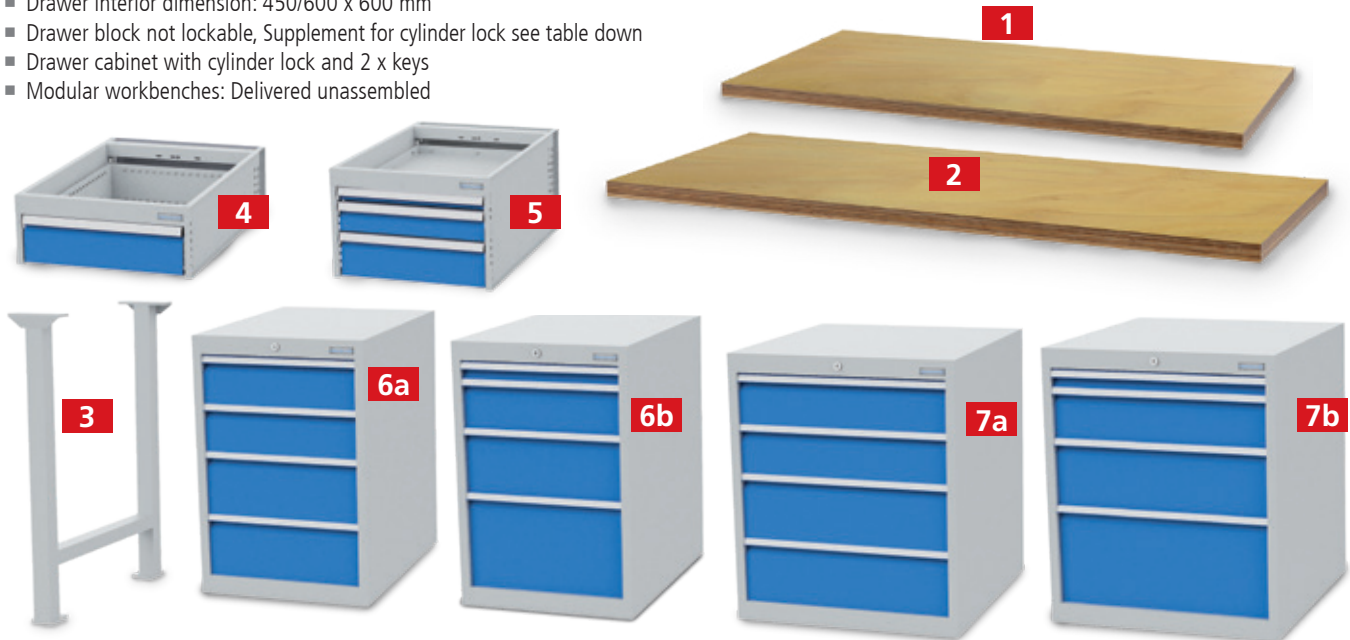

Modular workbench – individual components

Pos.	Ref.no.	Dimensions (W x D x H) mm	Version
1*	03.15.40B	1500 x 750 x 40	Beech multiplex worktop
2*	03.20.40B	2000 x 750 x 40	Beech multiplex worktop
3*	03.90.01B	150 x 650 x 819	Foot 50 x 50 x 2 mm
4	520/1VB	555 x 736 x 208	Drawer block T736 R 18-24, 1 x drawer 150 mm, on request also lockable
	520/1BM	–	Additional price with lock (adapted for Ref.no. 520/1B)
5	535/111VB	555 x 736 x 358	Drawer block T736 R 18-24, 1 x drawer 50 mm, 1 x drawer 100 mm, 1 x drawer 150 mm
	535/111BM	–	Additional price with lock (adapted for Ref.no. 535/111B)
6a*	580/0022VB	555 x 736 x 819	Drawer cabinet T736 R 18-24, 2 x drawers 150 mm, 2 x drawers 200 mm
6b	580/1111VB	555 x 736 x 819	Drawer cabinet T736 R 18-24, 1 x drawer 50 mm, 1 x drawer 150 mm, 1 x drawer 200 mm, 1 x drawer 300 mm
7a	780/0022VB	705 x 736 x 819	Drawer cabinet T736 R 24-24, 2 x drawers 150 mm, 2 x drawers 200 mm
7b	780/1111VB	705 x 736 x 819	Drawer cabinet T736 R 24-24, 1 x drawer 50 mm, 1 x drawer 150 mm, 1 x drawer 200 mm, 1 x drawer 300 mm

Modular workbench depth 750 | 1500 / 2000 x 750 x 859 mm (W x D x H) | R 18-24



- Beech multiplex worktop 40 mm
- 2 x double Feet
- 1 x drawer not lockable
- Supplement for cylinder lock - see table above

Ref.no.	Dimensions (W x D x H) mm
03.15.520.1VA	1500 x 750 x 859
03.20.520.1VA	2000 x 750 x 859



- Beech multiplex worktop 40 mm
- 2 x double Feet
- 3 x drawers not lockable
- Supplement for cylinder lock - see table above

Ref.no.	Dimensions (W x D x H) mm
03.15.535.2VA	1500 x 750 x 859
03.20.535.2VA	2000 x 750 x 859

Modular workbench depth 750 | 2000 x 750 x 859 mm (W x D x H) | R 18-24/24-24

- Beech multiplex worktop 40 mm
- Drawers with full pull-out 100%, load capacity 100 kg
- Delivered unassembled

Modular Workbench R 18-24

- 1 x double Feet
- Drawer cabinet 555 mm wide, 4 x drawers
- Drawer interior dimension: 450 x 600 mm

EXPRESS
72h

Ref.no.	Dimensions (W x D x H) mm
03.15.580.4VA	1500 x 750 x 859
03.20.580.4VA	2000 x 750 x 859



Energy ramp with 2 supports for the worktop

- Complete with 1 kit with 3 sockets and on/off switch and cable 2m long

Ref.no.	Dimensions (W x D x H) mm
07.861.15.74A	1500 x 60 x 130
07.861.20.74A	2000 x 60 x 130



R 24-24

- 1 x double Feet
- Drawer cabinet 705 mm wide, 4 x drawers
- Drawer interior dimension: 600 x 600 mm

Ref.no.	Dimensions (W x D x H) mm
03.20.780.4VA	2000 x 750 x 859

R 18-24

- 2 x Drawer cabinet 555 mm wide, je 4 x drawers
- Drawer interior dimension: 450 x 600 mm

EXPRESS
72h

Ref.no.	Dimensions (W x D x H) mm
03.20.580.20VA	2000 x 750 x 859



Heavy load table

- Beech multiplex worktop 40 mm
- Welded and bolted, from U-sections 75 x 50 x 2 mm
- Adjustable height in a raster of 25 mm
- Delivered unassembled (with mounting instruction)

Ref.no.	Dimensions (W x D x H) mm
03.10.000.6A	1000 x 750 x 734 - 1084
03.15.000.6A	1500 x 750 x 734 - 1084
03.20.000.6A	2000 x 750 x 734 - 1084



Workbenches and workstations

Wall hanging cabinets and workbenches

- Delivered unassembled



Foot with stepless height adjustment

- Adjustment of 200 mm

Ref.no.	Dimensions (W x D x H) mm
03.90.01HVA	150 x 650 x 819 - 1019

EXPRESS
72h



Modular Workbench

- Worktop beech multiplex 40 mm
- 2 x double Feet
- 1 x storage shelf on the bottom in half Depth

kg
200

EXPRESS
72h

Ref.no.	Dimensions (W x D x H) mm
03.15.000.2A	1500 x 750 x 859
03.20.000.2A	2000 x 750 x 859



Modular Workbench

- Worktop beech multiplex 40 mm
- 2 x double Feet
- Adjustable of 200 mm

kg
200

EXPRESS
72h

Ref.no.	Dimensions (W x D x H) mm
03.15.000.4A	1500 x 750 x 859 - 1059
03.20.000.4A	2000 x 750 x 859 - 1059



Modular Workbench

- Worktop beech multiplex 40 mm
- 2 x double Feet
- 1 x storage shelf on the bottom in half Depth
- Adjustable of 200 mm

kg
200

EXPRESS
72h

Ref.no.	Dimensions (W x D x H) mm
03.15.000.3A	1500 x 750 x 859 - 1059
03.20.000.3A	2000 x 750 x 859 - 1059

Workbenches and Worktables

- Delivery completely assembled



Workbench

- Beech multiplex worktop 40 mm
- Frame 40 x 40 x 2 mm
- Shelf in half depth

kg
200

Ref.no.	Dimensions (W x D x H) mm
03.14.30A	1500 x 750 x 859
03.19.30A	2000 x 750 x 859

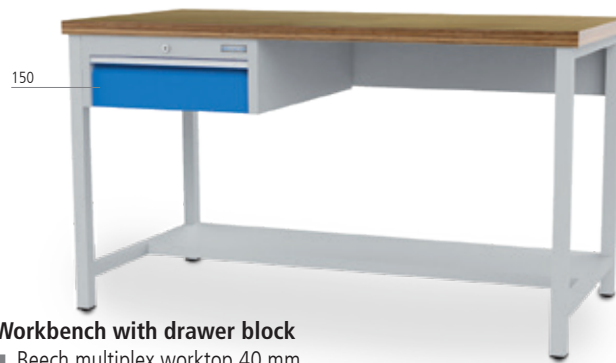

Workbench with drawer block

- Beech multiplex worktop 40 mm
- Frame 40 x 40 x 2 mm, with insered nuts
- Shelf in half depth
- Drawer block: 1 x drawer 150 mm

kg
200

Ref.no.	Dimensions (W x D x H) mm
03.14.31VA	1500 x 750 x 859
03.19.31VA	2000 x 750 x 859

- Drawers with full pull-out 100%, load capacity 100 kg
- Beech multiplex worktop 40 mm

NEW



R 18-24

- Left: 3 x drawers | right: 5 x drawers
- Drawer interior dimension: 450 x 600 mm

Ref.no.	Dimensions (W x D x H) mm
03.14.07VA	1500 x 750 x 859
03.14.07V9A	1500 x 750 x 959



R 18-24

- Left: 1 x hinged door, 1 x shelf | right: 4 x drawers
- Drawer interior dimension: 450 x 600 mm

Ref.no.	Dimensions (W x D x H) mm
03.14.19VA	1500 x 750 x 859
03.14.19V9A	1500 x 750 x 959



R 18-24

- Left: 4 x drawers | right: 3 x drawers
- Drawer interior dimension: 450 x 600 mm

Multi-Board

- 2 x Uprights 650 mm high, 2 x Perforated panels 2000 x 302 mm
- 1 x inclined shelf 2000 x 220 mm
- 11 x bins in different sizes
- Range of hooks, 10 parts
- 1 x Rails for bins 450 mm

Ref.no.	Dimensions (W x D x H) mm	Version
03.19.29VA	2000 x 750 x 859	Workbench
03.19.29V9A	2000 x 750 x 959	Workbench
03.900.20.25A	2000 x 650	Multi-Board

Lift/lower chassis retrofittable

- Total weight without workbench: 26 kg
- Dynamic load capacity: 450 kg
- Static load capacity: 1000 kg
- 2x steering caster, 2x fixed caster, Ø 80 mm, polyamide
- **Not possible for workbenches with half shelf**
- Only suitable for workbench height 859 mm

Ref.no.	For Workbench wide in mm
03.HUB12075A	1200
03.HUB15075A	1500
03.HUB20075A	2000



R 24-24

- Left: 1 x hinged door 600 mm, 1 x shelf
- Right: 4 x drawers
- Drawer interior dimension: 600 x 600 mm
- Delivery without perforated panel

Ref.no.	Dimensions (W x D x H) mm	Version
03.15.19VA	1500 x 750 x 859	Workbench
03.15.19V9A	1500 x 750 x 959	Workbench
03.87.103A	1500 x 450	perforated panel (without hooks)



Workbenches and workstations

Workbench R 18-24

- Drawers with full pull-out 100%, load capacity 100 kg
- Drawer interior dimension: 450 x 600 mm
- Beech multiplex worktop 40 mm
- Delivery completely assembled

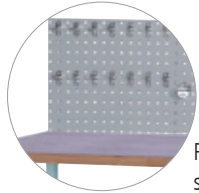

Perforated panel
s. page 18 below



- Left: Shelf in half depth
- Right: 1 x drawer, 1 x hinged door
- Delivery without perforated panel

Ref.no.	Dimensions (W x D x H) mm
03.14.12VA	1500 x 750 x 859
03.19.12VA	2000 x 750 x 859

Ref.no.	Dimensions (W x D x H) mm
03.14.12V9A	1500 x 750 x 959
03.19.12V9A	2000 x 750 x 959

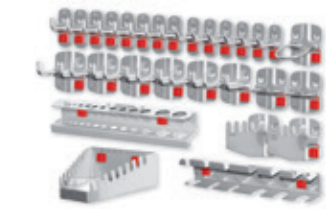

Range of hooks, 28 parts

Ref.no.
03.87.39528A



Height adjustment

- Height-adjustable on a grid of 25 mm
- Complete for a workbench with 4 feet
- Only suitable for workbench height 859 mm

Ref.no.
03.15.95A

EXPRESS
72h

- Left: Shelf in half depth
- Right: 3 x drawers



Ref.no.	Dimensions (W x D x H) mm
03.14.14VA	1500 x 750 x 859
03.19.14VA	2000 x 750 x 859

Ref.no.	Dimensions (W x D x H) mm
03.14.14V9A	1500 x 750 x 959
03.19.14V9A	2000 x 750 x 959



Ribbed rubber inserts

- Front 50 mm an more

Ref.no.
120A

BESTSELLER

EXPRESS
72h

- Left: Shelf in half depth
- Right: 4 x drawers



Ref.no.	Dimensions (W x D x H) mm
03.14.16VA	1500 x 750 x 859
03.19.16VA	2000 x 750 x 859

Ref.no.	Dimensions (W x D x H) mm
03.14.16V9A	1500 x 750 x 959
03.19.16V9A	2000 x 750 x 959

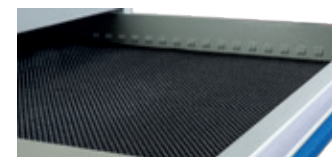

Non-slip mat

- W x D: 450 x 600 mm

Ref.no.
65.051.731A

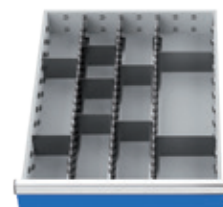

Metal dividers

- Front 150 mm

Ref.no.
116A

Perforated panel

- With 2 x fixing supports for workbench width 1500 mm
- With 3 x fixing supports for workbench width 2000 mm

Ref.no.	Dimensions (W x H) mm
03.87.103A	1500 x 450
03.87.104A	2000 x 450

Workbenches R 18-24

workbenches ans workstations

- Drawers with full pull-out 100%, load capacity 100 kg
- Drawer interior dimension: 450 x 600 mm
- Beech multiplex worktop 40 mm
- Delivery completely assembled



- Left: 1 x drawer, 1 x hinged door
- Middle: 1 x shelf in half depth, back panel
- Right: 1 x drawer, 1 x hinged door
- Delivery without perforated panel

Ref.no.	Dimensions (W x D x H) mm	Version
03.19.22VA	2000 x 750 x 859	Workbench
03.19.22V9A	2000 x 750 x 959	Workbench
03.87.104A	2000 x 450	perforated panel with 3 x fixing supports (without hooks)

EXPRESS
72h

- Left: 1 x drawer, 1 x hinged door
- Middle: 1 x shelf in half depth, back panel
- Right: 3 x drawers



Ref.no.	Dimensions (W x D x H) mm
03.19.24VA	2000 x 750 x 859
03.19.24V9A	2000 x 750 x 959

- Left: 1 x drawer, 1 x hinged door
- Middle: 1 x shelf in half depth, back panel
- Right: 4 x drawers



Ref.no.	Dimensions (W x D x H) mm
03.19.26VA	2000 x 750 x 859
03.19.26V9A	2000 x 750 x 959

Accessories for interior dimensions 450 x 600 mm



Metal dividers
■ Front 150 mm

Ref.no.
115A

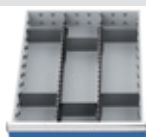

Metal dividers
■ Front 150 mm

Ref.no.
113A

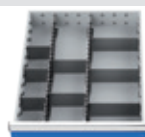

Metal dividers
■ Front 150 mm

Ref.no.
117A



Metal dividers
■ Front 200 mm

Ref.no.
118A

delivery without hooks and tools

Workbenches and workstations

Workbench R 24-24

- Drawers with full pull-out 100%, load capacity 100 kg
- Drawer interior dimension: 600 x 600 mm
- Beech multiplex worktop 40 mm
- Delivery completely assembled



- Left: 5 x drawers
- Right: 4 x drawers

Ref.no.	Dimensions (W x D x H) mm
03.15.55VA	1500 x 750 x 859
03.15.55V9A	1500 x 750 x 959



- Left: 5 x drawers
- Right: 4 x drawers

Ref.no.	Dimensions (W x D x H) mm
03.15.54VA	1500 x 750 x 859
03.15.54V9A	1500 x 750 x 959



- Left: 1 x hinged door, 1 x shelf
- Right: 3 x Drawers

Ref.no.	Dimensions (W x D x H) mm
03.15.17VA	1500 x 750 x 859
03.15.17V9A	1500 x 750 x 959



- Left: 2 x shelves 300 mm
- Right: 3 x drawers

Ref.no.	Dimensions (W x D x H) mm
03.15.03VA	1500 x 750 x 859
03.15.03V9A	1500 x 750 x 959



- Left: 1 x drawer, 1 x hinged door
- Right: 1 x drawer, 1 x hinged door

Ref.no.	Dimensions (W x D x H) mm
03.15.01VA	1500 x 750 x 859
03.15.01V9A	1500 x 750 x 959



- Left: 3 x drawers
- Right: 4 x drawers

Ref.no.	Dimensions (W x D x H) mm
03.15.34VA	1500 x 750 x 859
03.15.34V9A	1500 x 750 x 959

BESTSELLER



Dividing s. page 4, 5 and 21

Workbenches R 24-24

workbenches ans workstations

- Drawers with full pull-out 100%, load capacity 100 kg
- Drawer interior dimension: 600 x 600 mm
- Beech multiplex worktop 40 mm
- Delivery completely assembled



- Left: 1 x drawer, 1 x hinged door
- Middle: 2 x shelves 300 mm
- Right: 1 x drawer, 1 x hinged door

Ref.no.	Dimensions (W x D x H) mm
03.20.01VA	2000 x 750 x 859
03.20.01V9A	2000 x 750 x 959

EXPRESS
72h

- Left: 1 x hinged door, 1 x shelf
- Middle: 2 x shelves 300 mm
- Right: 4 x drawers



Ref.no.	Dimensions (W x D x H) mm
03.20.16VA	2000 x 750 x 859
03.20.16V9A	2000 x 750 x 959

- Left: 3 x drawers
- Middle: 2 x shelves 300 mm
- Right: 4 x drawers



Ref.no.	Dimensions (W x D x H) mm
03.20.17VA	2000 x 750 x 859
03.20.17V9A	2000 x 750 x 959

Accessories for interior dimensions 600 x 600 mm



Ribbed rubber inserts
■ Front 50 mm and more

Ref.no.
140A



Metal dividers
■ Front 150 mm

Ref.no.
135A

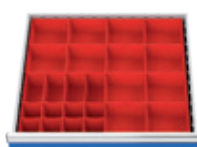

Small parts boxes
■ Front 100 - 150 mm

Ref.no.
134A



Metal dividers
■ Front 200 mm

Ref.no.
137A



Height adjustment

- Height-adjustable on a grid of 25 mm
- Complete for a workbench with 4 feet
- Only suitable for workbench height 859 mm

Ref.no.
03.15.95A

Dividing s. page 4 and 5

Workbenches and workstations

Multi-Board – Combinations

- Drawers with full pull-out 100%, load capacity 100 kg
- Drawer interior dimension: 450 x 600 mm
- Beech multiplex worktop 40 mm

Workbench T750 R 18-24

- Left: 1 x hinged door, 1 x shelf
- Middle: 3 x drawers
- Right: 1 x hinged door, 1 x shelf

Multi-Board 2000 mm consists of:

- 3 x Uprights 1250 mm high
- Overhead frame and rail
- 2 x Perforated panels each 1000 x 302 mm
- 2 x Magnetic panels each 1000 x 302 mm
- 1 x Passage for electronic cables with 3 sockets and on/off-switch
- 3 x shelves 1000 x 320 mm
- 2 x Rails for bins 450 mm
- Range of hooks, 10 parts
- 19 x bins in different sizes
- Optional: 1 x Light SL 108 eco-line 96,1 W, 1199 mm wide



Ref.no.	Dimensions (W x D x H) mm	Version
03.19.35VA	2000 x 750 x 859	Workbench
03.19.35V9A	2000 x 750 x 959	Workbench
03.900.20.1A	2000 x 1250	Multi-Board with light
03.900.20.10B	2000 x 1250	Multi-Board without light and overhead frame

- Drawers with full pull-out 100%
- Drawers with front height 50 mm - load capacity 70 kg
- Drawers with front height 75 mm and more - load capacity 100 kg
- Drawer interior dimension: 450 x 600 mm
- Beech multiplex worktop 40 mm

Workbench T 750 R 18-24

- Left: 5 x drawers
- Middle: 3 x drawers
- Right: 1 x hinged door, 1 shelf

Multi-Wand 2000 mm bestehend aus:

- 3 x Uprights 1250 mm high
- Overhead frame and rail
- 2 x Perforated panels each 1000 x 302 mm
- 2 x Magnetic panels each 1000 x 302 mm
- Optional: 2 x Light SL 78 eco-line 69,7 W, 899 mm wide



Ref.no.	Dimensions (W x D x H) mm	Version
03.19.36VA	2000 x 750 x 859	Workbench
03.19.36V9A	2000 x 750 x 959	Workbench
03.900.20.2A	2000 x 1250	Multi-Board with light
03.900.20.20B	2000 x 1250	Multi-Board without light and overhead frame

Dividing s. page 13, 18 and 19

- Drawers with full pull-out 100%, load capacity 100 kg
- Drawer interior dimension: 450 x 600 mm
- Beech multiplex worktop 40 mm

Workbench T750 R 18-24

- Left: 1 x shelf in half depth
- Right: 5 x drawers

Multi-Board 1500 mm Consists of:

- 2 x Uprights 1250 mm high
- Overhead frame and rail
- 1 x Perforated panels 1500 x 302 mm
- 1 x shelf 1500 x 320 mm
- Range of hooks, 10 parts
- 2 x Rails for bins 300 mm
- 12 x bins in different sizes
- Optional: 1 x Light SL 78 eco-line 69,7 W, 899 mm wide



Ref.no.	Dimensions (W x D x H) mm	Version
03.14.15VA	1500 x 750 x 859	Workbench
03.14.15V9A	1500 x 750 x 959	Workbench
03.900.15.320A	1500 x 1250	Multi-Board with light
03.900.15.3200B	1500 x 1250	Multi-Board without light and overhead frame

Dividing s. page 13, 18 and 19

- Drawers with full pull-out 100%, load capacity 100 kg
- Drawer interior dimension: 600 x 600 mm
- Beech multiplex worktop 40 mm

Workbench T750 R 24-24

- Left: 3 x drawers
- Right: 3 x drawers

Multi-Board without light and Overhead frame

- 2 x Uprights 1250 mm high
- Overhead frame and rail
- 1 x Perforated panels 1500 x 302 mm
- 1 x Magnetic panels 1500 x 302 mm
- 2 x shelves 1500 x 320 mm
- 1 x Passage for electronic cables with 3 sockets and on/off-switch
- Range of hooks, 10 parts
- 1 x Rails for bins 450 mm
- 20 x bins in different sizes
- Optional: 1 x Light SL 78 eco-line 69,7 W, 899 mm wide

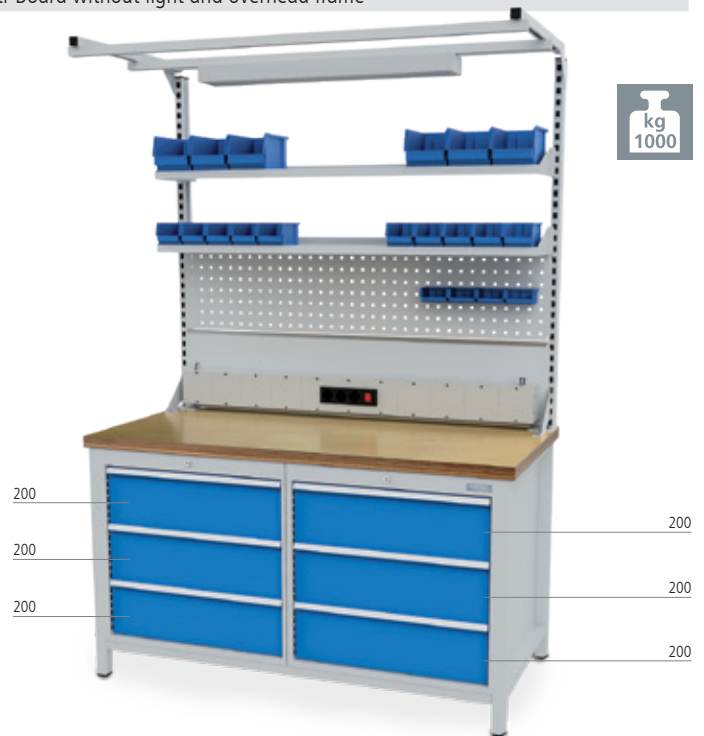

Ref.no.	Dimensions (W x D x H) mm	Version
03.15.33VA	1500 x 750 x 859	Workbench
03.15.33V9A	1500 x 750 x 959	Workbench
03.900.14.16A	1500 x 1250	Multi-Board with light
03.900.14.160B	1500 x 1250	Multi-Board without light and overhead frame

Dividing s. page 4, 5 and 21

Mobile logistic systems

WAF – Work assembly frame



Stepless height adjustment



Work assembly frame

- Equipped with 4x plastic steering caster, thereof 2 with locks, Ø 80 mm
- Ripped rubber mat

Ref.no.	Dimensions (W x D x H) mm
05.10.03B	600 x 400 x 800 - 1450



BESTSELLER

Work assembly frame

- Equipped with 4x plastic steering caster, thereof 2 with locks, Ø 100 mm
- Ripped rubber mat

Ref.no.	Dimensions (W x D x H) mm
05.10.02B	600 x 400 x 900 - 1500



Stepless incline up to 30°



Work assembly frame Up to 30° inclinable

- Equipped with 4x plastic steering caster, thereof 2 with locks, Ø 80 mm
- Ripped rubber mat

Ref.no.	Dimensions (W x D x H) mm
05.10.05B	600 x 400 x 800 - 1450



Work assembly frame, Up to 30° inclinable

- Equipped with 4x plastic steering caster, thereof 2 with locks, Ø 100 mm
- Ripped rubber mat

Ref.no.	Dimensions (W x D x H) mm
05.10.04B	600 x 400 x 900 - 1500



Standing aid and Working chairs

EXPRESS
72h



Standing aid with ergonomic comfort seating, PU black

- Seat height 600 - 800 mm
- Low maintenance integral foam
- Tilted seating with 15 degrees adjustable
- 16 degrees horizontal all-round swivel

Ref.no.
05.96.28A

EXPRESS
72h



Working chair, PU black with wheels

- Seat height 470 - 670 mm
- Seat tilt 12 degrees
- Ergonomic design, asynchronous mechanic for continuous adjustment of seat and backrest tilt

Ref.no.
05.96.22A

EXPRESS
72h



Working chair, PU black

- Seat height 520 - 720 mm
- Large polyurethane and cushion seats and backrests
- Seat tilt 12 degrees
- Ergonomic design, asynchronous mechanic for continuous adjustment of seat and backrest tilt
- Synthetic star base

Ref.no.
05.96.46A

Mobile Drawer cabinets depth 500 R 18-16

Mobile logistic systems



Please, always indicate the colour/colours. Without indication we supply housing RAL 7035 light grey and fronts RAL 5012 light blue.

Pictures with housing in RAL 7035 and fronts RAL 3020.

- Drawers with full pull-out 100%, load capacity 50 kg
- Push handle
- Central locking system

BESTSELLER



- 4 x drawers

Ref.no.	Dimensions (W x D x H) mm
46.301BR80	530 x 500 x 750

- Incl. roll-off edge on 3 sides
- 4 x castor wheels Ø 80 mm, 2 x with locking device
- Drawer interior dimension: 450 x 400 mm

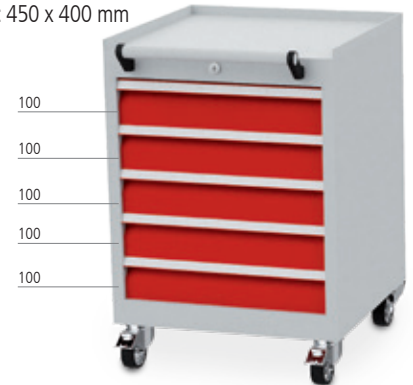

- 5 x drawers

Ref.no.	Dimensions (W x D x H) mm
46.500BR80	530 x 500 x 750



Ribbed rubber inserts
■ Front 75 mm and more

Ref.no.
65.046.531A



Metal dividers
■ Front 100 mm

Ref.no.
146-139B



Small parts boxes
■ Front 100 mm

Ref.no.
146-132A



Metal dividers
■ Front 200 mm

Ref.no.
146-144A



Non-slip mat
■ W x D: 530 x 500 mm

Ref.no.
65.040.530A

Mobile Drawer cabinets depth 500 R 24-16

- Drawers with full pull-out 100%, load capacity 50 kg
- Push handle
- Central locking system

NEW



- 6 drawers

Ref.no.	Dimensions (W x D x H) mm
68.2310AM	680 x 500 x 890

- Incl. roll-off edge on 3 sides
- 4 x castor wheels Ø 125 mm, 2 x with locking device
- Drawer interior dimension: 600 x 400 mm



- 7 x drawers

Ref.no.	Dimensions (W x D x H) mm
68.700AM	680 x 500 x 990



Ribbed rubber inserts
■ Front 75 mm and more

Ref.no.
65.068.530A



Small parts boxes
■ Front 100 mm

Ref.no.
168-132A



Metal dividers
■ Front 100 mm

Ref.no.
168-139A



Metal dividers
■ Front 150 mm

Ref.no.
168-135A



Metal dividers
■ Front 200 mm

Ref.no.
168-144A



Non-slip mat
■ W x D: 680 x 500 mm

Ref.no.
65.060.530A

Mobile logistic systems

Mobile workbenches depth 500 R 18-16



Please, always indicate the colour/colours. Without indication we supply housing RAL 7035 light grey and fronts RAL 5012 light blue.

Pictures with housing in RAL 7035 and fronts RAL 3020.

Workshop trolleys T500 R 18-16

- Drawers with full pull-out 100%, load capacity 50 kg
- With individual interlocking and 2 housing variants
- Drawer interior dimension: 450 x 400 mm



- Left: 4 x drawers
- Right: 4 x drawers

Ref.no.	Dimensions (W x D x H) mm
04.11.08A	1060 x 500 x 995

- Push handle
- Central locking system
- 4 x Castor wheels Ø 80 mm, 2 x with locking device
- Incl. roll-off edge on 4 sides and ripped rubber mat



- Left: 5 x drawers
- Right: 1 x hinged door and shelf

Ref.no.	Dimensions (W x D x H) mm
04.11.05A	1060 x 500 x 995

Mobile workbench T500 R 18-16

- Beech multiplex worktop 25 mm
- Drawers with full pull-out 100%, load capacity 50 kg
- Drawer interior dimension: 450 x 400 mm
- 4 x castor wheels Ø 125 mm, 2 x with locking device
- Push handle



- Left: 2 x shelves
- Right: 3 x drawers

Ref.no.	Dimensions (W x D x H) mm
04.512.03A	1200 x 540 x 880



BESTSELLER



- Left: 2 x shelves, Right: 4 x drawers
- 2 x Uprights 650 mm, 1 x Perforated panels, 1 x magnetic panel

Ref.no.	Dimensions (W x D x H) mm	Version
04.512.04A	1200 x 540 x 880	Mobile workbench
03.900.12.02A	1000 x 600	Multi-Board

Accessories for interior dimensions 450 x 400 mm



- Ribbed rubber inserts
- Front 75 mm and more

Ref.no.
65.046.531A



- Small parts boxes
- Front 100 mm

Ref.no.
146-132A

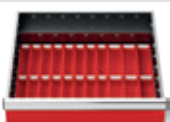

- Trough plates
- Front 100 mm

Ref.no.
146-130A



- Metal dividers
- Front 100 mm

Ref.no.
146-139B



- Metal dividers
- Front 150 mm

Ref.no.
146-135A



- Metal dividers
- Front 200 mm

Ref.no.
146-144A

Delivery without decoration and hooks

Mobile workbench depth 600

Mobile logistic systems

Mobile workbench T600

- Beech multiplex worktop 25 mm
- Drawers with single pull-out 88 %, load capacity 35 kg
- Drawers on roller bearings

- Drawer interior dimension: 450 x 525 mm
- 2x fixed and 2x steering caster with locks, Ø 200 mm
- Push handle



Mobile Workbench

- Left: 1 x hinged door
- Right: 2x beech multiplex shelf 25 mm

Mobile Workbench

- Left: 4 x drawers
- Right: 1 x hinged door

Ref.no.	Dimensions (W x D x H) mm
04.12.80A	1200 x 600 x 820

Ref.no.	Dimensions (W x D x H) mm
04.12.82A	1200 x 600 x 820

Accessories for interior dimensions 450 x 525 mm

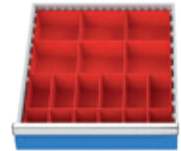
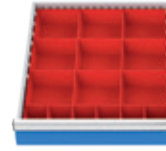
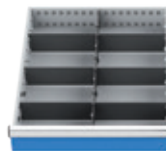
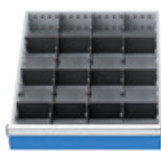

Small parts boxes

- Front 100 mm

Metal dividers

- Front 100 mm

Metal dividers

- Front 100 mm

Small parts boxes

- Front 100 mm

Small parts boxes

- Front 100 mm

Ref.no.
128-7A

Ref.no.
128-3A

Ref.no.
128-1A

Ref.no.
128-5A

Ref.no.
128-6A

Trolley

- 4 x wheels Ø 125 mm, 2 x with locking device
- Push handle
- Frame in steel tube 40 x 40 x 2 mm



- Chassis with 2 x wheels and 2 x castor wheels with locking device Ø 125 mm
- Frame in steel tube 40 x 40 x 2 mm



- Beech multiplex worktop 40 mm
- Shelf in beech multiplex 25 mm

- With 2 levels of wooden shelves

Ref.no.	Dimensions (W x D x H) mm
04.12.01A	1200 x 750 x 859
04.15.01A	1500 x 750 x 859

Ref.no.	Dimensions (W x D x H) mm
04.900.04A	900 x 620 x 860

Mobile logistic systems

Mobile Werkbänke Tiefe 736 R 18-24

- Drawers with full pull-out 100%
- Drawers with front height 50 mm - load capacity 70 kg
- Drawers with front height 75 mm and more - load capacity 100 kg
- Drawer interior dimension: 450 x 600 mm
- 4 x Wheels Ø 125 mm, 2 x with locking device
- Push handle

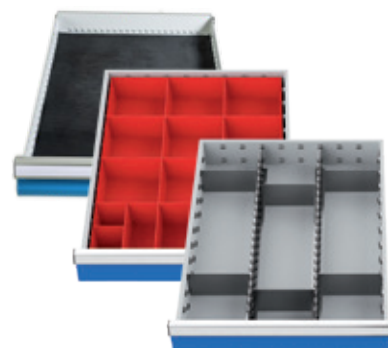

Divider set T736 R 18-24

- Ribbed rubber inserts Front 50-200 mm
- Small parts boxes Front 100-150 mm
- Metal dividers Front 150 mm

- Beech multiplex worktop 40 mm
- Left: 1 x hinged door
- Right: 4 x drawers

Ref.no.	Dimensions (W x D x H) mm
04.12.05VA	1250 x 750 x 859

Ref.no.	Dimensions (W x H) mm
500/583A	

BESTSELLER

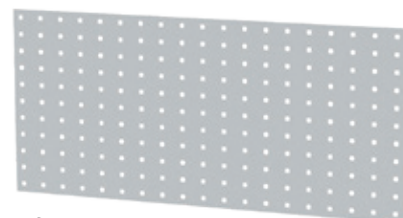

Perforated panel

- With 2 x fixing supports

- Beech multiplex worktop 25 mm
- Left: 4 x drawers
- Right: 1 x hinged door and shelf

Ref.no.	Dimensions (W x D x H) mm
04.12.19VA	1250 x 750 x 935

Ref.no.	Dimensions (W x H) mm
03.87.102A	1000 x 450

**EXPRESS
72h**

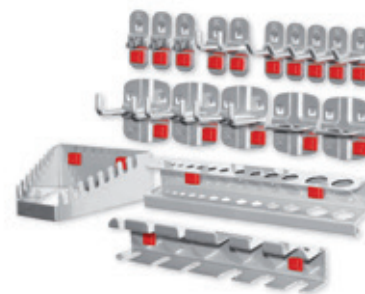

Range of hooks, 18 parts

Combination

Mobile workbench T736 R 18-24

- Consists of 04.12.19VA + 03.87.102A + 03.87.39518A + 500/583A

Ref.no.	Dimensions (W x D x H) mm
04.12.19VAK	

Ref.no.	Dimensions (W x H) mm
03.87.39518A	

Mobile Workbench Tiefe 750 mm R 18-24

Mobile logistic systems

- Drawers with full pull-out 100%, load capacity 100 kg
- Drawer interior dimension: 450 x 600 mm
- Beech multiplex worktop 1250 x 750 x 40 mm
- Chassis with 2 x wheels and 2 x castor wheels with locking device Ø 200 mm
- Push handle
- Dividing Sets s. page 13, 18 and 19



- Left: 4 x drawers
- Right: 5 x drawers

Ref.no.	Dimensions (W x D x H) mm
04.12.29VA	1250 x 750 x 995



- Left: 4 x drawers
- Right: 4 x drawers

Ref.no.	Dimensions (W x D x H) mm
04.12.28VA	1250 x 750 x 995

Mobile workbench depth 750 mm R 24-24 | 1500 mm wide

- Drawers with full pull-out 100%, load capacity 100 kg
- Drawer interior dimension: 600 x 600 mm
- 4 x Swivel wheels ø125 mm, 2 with brake
- Push handle
- Beech multiplex worktop 1500 x 750 x 40 mm
- Dividing Set s. page 4, 5, 21 and 24



Mobile workbench

- Left: 4 x drawers
- Right: 1 x hinged door

Ref.no.	Dimensions (W x D x H) mm
04.15.41VA	1500 x 750 x 859



- Left: 3 x drawers | Right: 3 x drawers

Multi-Board

- 2 x Uprights 1250 mm, 1 x Perforated panels, 1 x magnetic panel
- 1 x shelf 320 mm
- 1 x Overhead frame, 1 x rail



Ref.no.	Dimensions in mm	Version
04.15.33VA	1500 x 750 x 859	Mobile workbench
03.900.15.30A	1500 x 1250	Multi-Wand

Mobile logistic systems

PC-cabinet mobile

- All models are available fixed or mobile



- 1 x Monitor attachment housing 700 x 270 x 500 mm (W x D x H)
- Used for 21" Monitor
- Beech multiplex worktop 25 mm
- 1 x drawer, 1 x shelf, 2 x hinged door, 1 x 4-way socket bar
- Square holes in rear wall for ventilation
- 2x fixed and 2x steering caster with locks, Ø 125 mm

Ref.no.	Dimensions (W x D x H) mm	Version
04.980.04A	1200 x 700 x 1796	Full pull-out 100 %, 50 kg

BESTSELLER



- 1 x Perforated panels with flat screen bracket
- 1 x shelf, 2 x hinged door, 1 x desk attachment, 1 x 4-way socket bar
- 1 x Keyboard drawer
- Square holes in rear wall for ventilation
- 4x steering caster, Ø 125 mm, thereof 2 with locks

Ref.no.	Dimensions (W x D x H) mm
04.680.C125A	680 x 500 x 1610



- Beech multiplex worktop 25 mm
- 1 x drawer, 1 x shelf, 1 x hinged door, 1 x 4-way socket bar
- Square holes in rear wall for ventilation
- 4x steering caster, Ø 125 mm, thereof 2 with locks

Ref.no.	Dimensions (W x D x H) mm	Version
04.530.02A	530 x 500 x 1000	Full pull-out 100 %, 50 kg



- 1 x Monitor attachment housing 700 x 270 x 500 mm (W x D x H)
- Used for 21" Monitor
- Beech multiplex worktop 25 mm
- 1 x shelf, 2 x hinged door, 1 x 4-way socket bar
- Cable passages
- Square holes in rear wall for ventilation
- 4x steering caster, Ø 125 mm, thereof 2 with locks

Ref.no.	Dimensions (W x D x H) mm
04.680.02A	750 x 500 x 1600

Delivery without decoration

Cabinet with hinged doors Type 105 + 110

New Drawers with Full pull-out 100%

Cabinet with hinged doors

BESTSELLER



Cabinet with hinged doors Type 110

- 1 x Metal border
- 2 x drawers with full pull-out (VA) 100 %, load capacity 50 kg
- 2 x shelves

Ref.no.	Dimensions (W x D x H) mm
04.110B	1000 x 500 x 1000

Cabinet with hinged door Type 105

- 2 x shelves
- 1 x Metal border
- 2 x drawers with full pull-out (VA) 100 %, load capacity 50 kg

Ref.no.	Dimensions (W x D x H) mm
04.105B	500 x 500 x 1000

Combination

Hinged door cabinet Typ 105

- consists of cabinet with hinged door Type 105, desk attachment and Roller support Ø 125 mm

Ref.no.	Dimensions (W x D x H) mm
04.105K125	500 x 500 x 1400

Roller support

- 4 x castor wheels Ø 125 mm, 2 x with brake

Ref.no.	Dimensions (W x D x H) mm
04.110.RU125	1000 x 500 x 150

BESTSELLER



Both cabinets with hinged doors on this page in RAL 7035/5012, housing light grey and doors in light blue or totally in light grey, other colours on demand.



Cabinet with hinged doors

Ref.no.	Dimensions (W x D x H) mm	Version
04.155.04A	930 x 500 x 1950	Cabinet with hinged doors, incl. 4 shelves
04.155.04FB	Load capacity 80 kg	Extra shelves
04.156.04A	930 x 600 x 1950	Cabinet with hinged doors, incl. 4 shelves
04.156.04FB	Load capacity 80 kg	Extra shelves

Cabinet with hinged doors

Ref.no.	Dimensions (W x D x H) mm	Version
04.155.12A	1200 x 500 x 1950	Cabinet with hinged doors, incl. 4 shelves
04.155.12FB	Load capacity 80 kg	Extra shelves
04.156.12A	1200 x 600 x 1950	Cabinet with hinged doors, incl. 4 shelves
04.156.12FB	Load capacity 80 kg	Extra shelves

Electronically controlled drawer cabinet

Tool-Server-Modular (TSM®) R 24-24

Tool dispensing system

- Drawers with full pull-out 100%
- Drawers with front height 50 mm - load capacity 60 kg
- Drawers with front height 100 mm and more - load capacity 100 kg
- Drawer interior dimension: 600 x 600 mm
- All modules including **pallet truck plinth** in the housing colours
- Supplement for delivery, installation and training

Software Video



More Informations see
TSM® Catalogue



TSM® - Basic module

- 8 x drawers
- Incl. storage and management software
- With touch-display

Ref.no.	Dimensions (W x D x H) mm
TS5G00700080A	700 x 725 x 1019

TSM® - Extension module

- 8 x drawers
- Incl. storage and management software for link with basic cabinet

Ref.no.	Dimensions (W x D x H) mm
TS5A00700080A	700 x 725 x 1019

Drawer divider

R 24-24



Trough plates

- Front 50 mm

Ref.no.
TS-7-04A

Small parts boxes

- Front 50 mm

Ref.no.
TS-7-13-050A

Metal dividers

- Front 100 mm

Ref.no.
TS-7-27-100A

Metal dividers

- Front 150 mm

Ref.no.
TS-7-26-150A

Metal dividers

- Front 200 mm

Ref.no.
TS-7-20-200A

Electronic divider

- Front 100 mm

Ref.no.
TS7K160-100A



bedrunka+hirth

Workplace up to date – mehr Raum zum Arbeiten

Offers apply to commercial and craft activities.

Technical and price variations are possible given the price of raw material. The price is calculated without VAT, except mistakes or omission. You'll find the general terms of Bedrunka+Hirth Gerätebau GmbH on our website www.bedrunka-hirth.de/en