

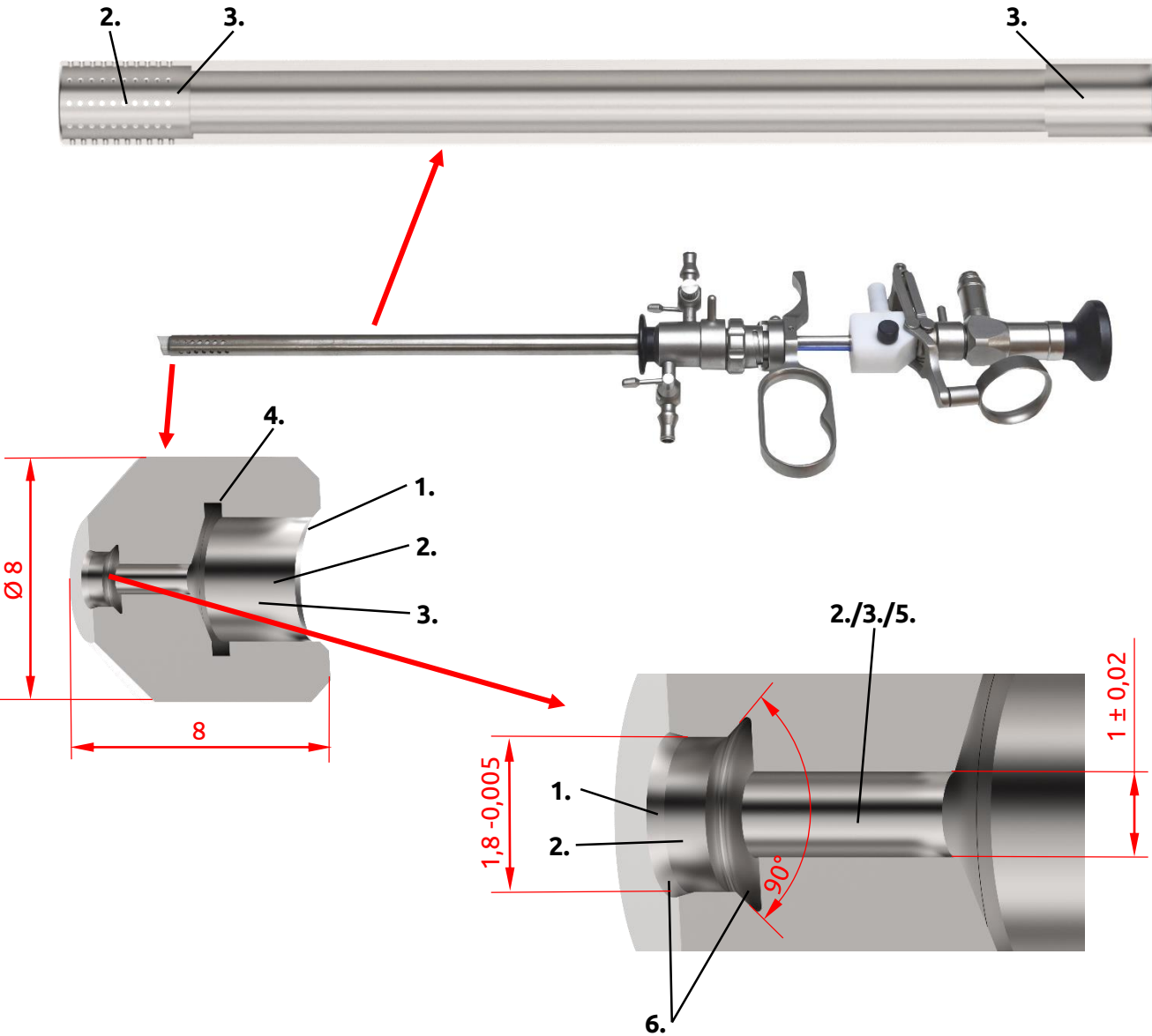





Bearbeitungsbeispiel: Resektoskop – Rohr- und Linsensitz



- 1. **DRP - Punktanbohrer**

- 2. **DRA - Hochleistungs-Anfasbohrer**

- 3. **SDG - Bohrstange**

- 4. **SDS - Innen-Einsteckstahl / SDT - Innen-Stechedrehstahl**

- 5. **DRE - Präzisions Reibwerkzeug oder Stufenreibahle**

- 6. **SDW - Auskammerstahl**

- 7. **Werkzeuge zur Herstellung von speziellen Profilen auf Kundenwunsch**
