

**Werkzeughalter-System für  
Ein- und Mehrspindel-Drehautomaten  
Schnellwechselbar und voreinstellbar**

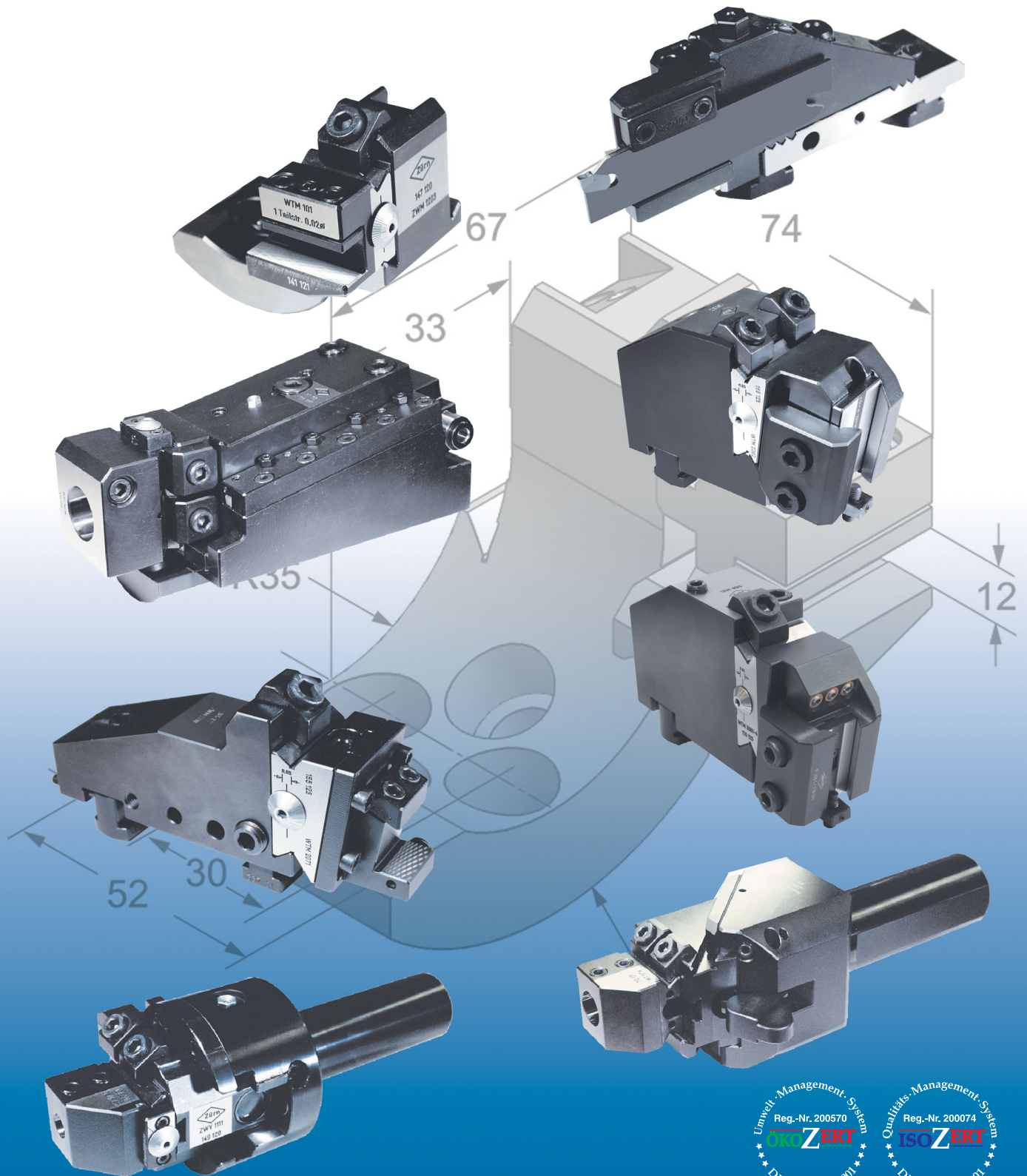

**Katalog Nr. 169  
Catalogue No. 169**

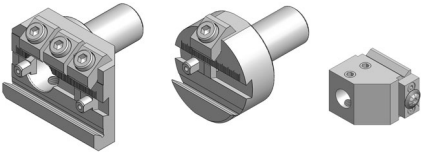
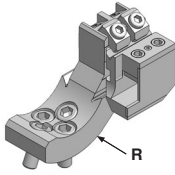
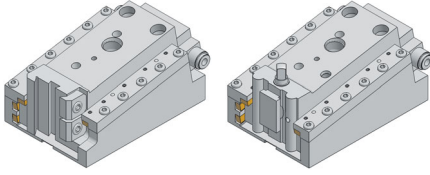
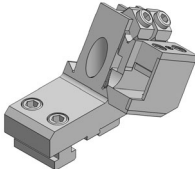
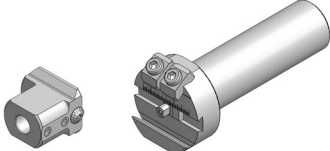
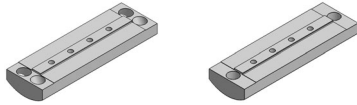
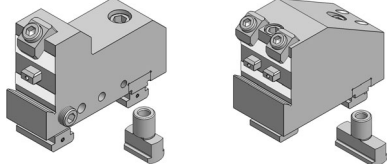
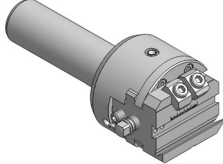
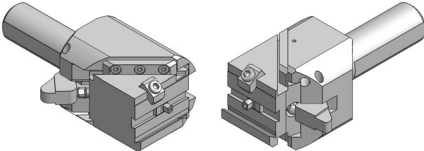

| <p><b>Grundwerkzeughalter und Werkzeugträger mit zylindrischer Aufnahme</b></p>   | <p><b>Grundwerkzeughalter und Werkzeugträger zum Längsdrehen für Schütze</b></p>   | <p><b>Schwere Einstechschieber für Schütze</b></p>   |          |                             |          |                             |          |                             |          |  |          |                             |        |                             |        |                             |        |                             |        |            |        |          |        |          |        |          |        |            |        |                         |   |                          |        |                          |                              |                          |                              |                          |                              |                          |                              |                          |  |           |                           |                |                           |           |                           |           |                           |           |                           |  |        |            |          |            |        |             |        |            |          |            |        |            |        |            |          |            |        |            |  |   |          |     |        |           |        |           |
|--|---|---|----------|-----------------------------|----------|-----------------------------|----------|-----------------------------|----------|--|----------|-----------------------------|--------|-----------------------------|--------|-----------------------------|--------|-----------------------------|--------|------------|--------|----------|--------|----------|--------|----------|--------|------------|--------|-------------------------|---|--------------------------|--------|--------------------------|------------------------------|--------------------------|------------------------------|--------------------------|------------------------------|--------------------------|------------------------------|--------------------------|--|-----------|---------------------------|----------------|---------------------------|-----------|---------------------------|-----------|---------------------------|-----------|---------------------------|--|--------|------------|----------|------------|--------|-------------|--------|------------|----------|------------|--------|------------|--------|------------|----------|------------|--------|------------|--|---|----------|-----|--------|-----------|--------|-----------|
| <table border="1"> <thead> <tr> <th>Art.-Nr.</th> <th>Typ</th> </tr> </thead> <tbody> <tr><td>104120</td><td>ZW 1105 <math>\varnothing</math>25,00</td></tr> <tr><td>105120</td><td>ZW 1106 <math>\varnothing</math>25,40</td></tr> <tr><td>106120</td><td>ZW 1107 <math>\varnothing</math>31,75</td></tr> <tr><td>107120</td><td>ZW 1110 <math>\varnothing</math>25,00</td></tr> <tr><td>108120</td><td>ZW 1111 <math>\varnothing</math>25,40</td></tr> <tr><td>111120</td><td>ZW 1112 <math>\varnothing</math>30,00</td></tr> <tr><td>109120</td><td>ZW 1113 <math>\varnothing</math>31,75</td></tr> <tr><td>110120</td><td>ZW 1114 <math>\varnothing</math>40,00</td></tr> <tr><td>101121</td><td>WT 1061</td></tr> <tr><td>102121</td><td>WT 1062</td></tr> <tr><td>103121</td><td>WT 1063</td></tr> <tr><td>104121</td><td>WT 1064</td></tr> <tr><td>105121</td><td>WT 1065</td></tr> <tr><td>106121</td><td>WT 1070 <math>\varnothing</math> 8</td></tr> <tr><td>107121</td><td>WT 1071 <math>\varnothing</math>10</td></tr> <tr><td>108121</td><td>WT 1072 <math>\varnothing</math>12</td></tr> <tr><td>109121</td><td>WT 1073 <math>\varnothing</math>16</td></tr> <tr><td>112121</td><td>WT 1076 <math>\varnothing</math>18</td></tr> <tr><td>110121</td><td>WT 1074 <math>\varnothing</math>20</td></tr> <tr><td>111121</td><td>WT 1075 <math>\varnothing</math>25</td></tr> </tbody> </table> | Art.-Nr.  | Typ   | 104120   | ZW 1105 $\varnothing$ 25,00 | 105120   | ZW 1106 $\varnothing$ 25,40 | 106120   | ZW 1107 $\varnothing$ 31,75 | 107120   | ZW 1110 $\varnothing$ 25,00  | 108120   | ZW 1111 $\varnothing$ 25,40 | 111120 | ZW 1112 $\varnothing$ 30,00 | 109120 | ZW 1113 $\varnothing$ 31,75 | 110120 | ZW 1114 $\varnothing$ 40,00 | 101121 | WT 1061    | 102121 | WT 1062  | 103121 | WT 1063  | 104121 | WT 1064  | 105121 | WT 1065    | 106121 | WT 1070 $\varnothing$ 8 | 107121  | WT 1071 $\varnothing$ 10 | 108121 | WT 1072 $\varnothing$ 12 | 109121                       | WT 1073 $\varnothing$ 16 | 112121                       | WT 1076 $\varnothing$ 18 | 110121                       | WT 1074 $\varnothing$ 20 | 111121                       | WT 1075 $\varnothing$ 25 | <table border="1"> <thead> <tr> <th>Art.-Nr.</th> <th>Typ</th> <th>R</th> </tr> </thead> <tbody> <tr><td>145120</td><td>ZWM 1201</td><td>32</td></tr> <tr><td>146120</td><td>ZWM 1202</td><td>40</td></tr> <tr><td>147120</td><td>ZWM 1203</td><td>56</td></tr> <tr><td>150122</td><td>ZWM 2203</td><td>65</td></tr> <tr><td>151122</td><td>ZWM 2204/05</td><td>72,5</td></tr> <tr><td>141121</td><td>WTM 1001</td><td></td></tr> <tr><td>141123</td><td>WTM 2201</td><td></td></tr> <tr><td>142123</td><td>WTM 2202</td><td></td></tr> <tr><td>143123</td><td>WTM 2203</td><td></td></tr> </tbody> </table> | Art.-Nr.  | Typ                       | R              | 145120                    | ZWM 1201  | 32                        | 146120    | ZWM 1202                  | 40        | 147120                    | ZWM 1203   | 56     | 150122     | ZWM 2203 | 65         | 151122 | ZWM 2204/05 | 72,5   | 141121     | WTM 1001 |            | 141123 | WTM 2201   |        | 142123     | WTM 2202 |            | 143123 | WTM 2203   |  | <table border="1"> <thead> <tr> <th>Art.-Nr.</th> <th>Typ</th> </tr> </thead> <tbody> <tr><td>207122</td><td>ZWME 2220</td></tr> <tr><td>221128</td><td>ZWME 2221</td></tr> </tbody> </table> | Art.-Nr. | Typ | 207122 | ZWME 2220 | 221128 | ZWME 2221 |
| Art.-Nr.   | Typ   |   |          |                             |          |                             |          |                             |          |  |          |                             |        |                             |        |                             |        |                             |        |            |        |          |        |          |        |          |        |            |        |                         |   |                          |        |                          |                              |                          |                              |                          |                              |                          |                              |                          |  |           |                           |                |                           |           |                           |           |                           |           |                           |  |        |            |          |            |        |             |        |            |          |            |        |            |        |            |          |            |        |            |  |   |          |     |        |           |        |           |
| 104120   | ZW 1105 $\varnothing$ 25,00   |   |          |                             |          |                             |          |                             |          |  |          |                             |        |                             |        |                             |        |                             |        |            |        |          |        |          |        |          |        |            |        |                         |   |                          |        |                          |                              |                          |                              |                          |                              |                          |                              |                          |  |           |                           |                |                           |           |                           |           |                           |           |                           |  |        |            |          |            |        |             |        |            |          |            |        |            |        |            |          |            |        |            |  |   |          |     |        |           |        |           |
| 105120   | ZW 1106 $\varnothing$ 25,40   |   |          |                             |          |                             |          |                             |          |  |          |                             |        |                             |        |                             |        |                             |        |            |        |          |        |          |        |          |        |            |        |                         |   |                          |        |                          |                              |                          |                              |                          |                              |                          |                              |                          |  |           |                           |                |                           |           |                           |           |                           |           |                           |  |        |            |          |            |        |             |        |            |          |            |        |            |        |            |          |            |        |            |  |   |          |     |        |           |        |           |
| 106120   | ZW 1107 $\varnothing$ 31,75   |   |          |                             |          |                             |          |                             |          |  |          |                             |        |                             |        |                             |        |                             |        |            |        |          |        |          |        |          |        |            |        |                         |   |                          |        |                          |                              |                          |                              |                          |                              |                          |                              |                          |  |           |                           |                |                           |           |                           |           |                           |           |                           |  |        |            |          |            |        |             |        |            |          |            |        |            |        |            |          |            |        |            |  |   |          |     |        |           |        |           |
| 107120   | ZW 1110 $\varnothing$ 25,00   |   |          |                             |          |                             |          |                             |          |  |          |                             |        |                             |        |                             |        |                             |        |            |        |          |        |          |        |          |        |            |        |                         |   |                          |        |                          |                              |                          |                              |                          |                              |                          |                              |                          |  |           |                           |                |                           |           |                           |           |                           |           |                           |  |        |            |          |            |        |             |        |            |          |            |        |            |        |            |          |            |        |            |  |   |          |     |        |           |        |           |
| 108120   | ZW 1111 $\varnothing$ 25,40   |   |          |                             |          |                             |          |                             |          |  |          |                             |        |                             |        |                             |        |                             |        |            |        |          |        |          |        |          |        |            |        |                         |   |                          |        |                          |                              |                          |                              |                          |                              |                          |                              |                          |  |           |                           |                |                           |           |                           |           |                           |           |                           |  |        |            |          |            |        |             |        |            |          |            |        |            |        |            |          |            |        |            |  |   |          |     |        |           |        |           |
| 111120   | ZW 1112 $\varnothing$ 30,00   |   |          |                             |          |                             |          |                             |          |  |          |                             |        |                             |        |                             |        |                             |        |            |        |          |        |          |        |          |        |            |        |                         |   |                          |        |                          |                              |                          |                              |                          |                              |                          |                              |                          |  |           |                           |                |                           |           |                           |           |                           |           |                           |  |        |            |          |            |        |             |        |            |          |            |        |            |        |            |          |            |        |            |  |   |          |     |        |           |        |           |
| 109120   | ZW 1113 $\varnothing$ 31,75   |   |          |                             |          |                             |          |                             |          |  |          |                             |        |                             |        |                             |        |                             |        |            |        |          |        |          |        |          |        |            |        |                         |   |                          |        |                          |                              |                          |                              |                          |                              |                          |                              |                          |  |           |                           |                |                           |           |                           |           |                           |           |                           |  |        |            |          |            |        |             |        |            |          |            |        |            |        |            |          |            |        |            |  |   |          |     |        |           |        |           |
| 110120   | ZW 1114 $\varnothing$ 40,00   |   |          |                             |          |                             |          |                             |          |  |          |                             |        |                             |        |                             |        |                             |        |            |        |          |        |          |        |          |        |            |        |                         |   |                          |        |                          |                              |                          |                              |                          |                              |                          |                              |                          |  |           |                           |                |                           |           |                           |           |                           |           |                           |  |        |            |          |            |        |             |        |            |          |            |        |            |        |            |          |            |        |            |  |   |          |     |        |           |        |           |
| 101121   | WT 1061   |   |          |                             |          |                             |          |                             |          |  |          |                             |        |                             |        |                             |        |                             |        |            |        |          |        |          |        |          |        |            |        |                         |   |                          |        |                          |                              |                          |                              |                          |                              |                          |                              |                          |  |           |                           |                |                           |           |                           |           |                           |           |                           |  |        |            |          |            |        |             |        |            |          |            |        |            |        |            |          |            |        |            |  |   |          |     |        |           |        |           |
| 102121   | WT 1062   |   |          |                             |          |                             |          |                             |          |  |          |                             |        |                             |        |                             |        |                             |        |            |        |          |        |          |        |          |        |            |        |                         |   |                          |        |                          |                              |                          |                              |                          |                              |                          |                              |                          |  |           |                           |                |                           |           |                           |           |                           |           |                           |  |        |            |          |            |        |             |        |            |          |            |        |            |        |            |          |            |        |            |  |   |          |     |        |           |        |           |
| 103121   | WT 1063   |   |          |                             |          |                             |          |                             |          |  |          |                             |        |                             |        |                             |        |                             |        |            |        |          |        |          |        |          |        |            |        |                         |   |                          |        |                          |                              |                          |                              |                          |                              |                          |                              |                          |  |           |                           |                |                           |           |                           |           |                           |           |                           |  |        |            |          |            |        |             |        |            |          |            |        |            |        |            |          |            |        |            |  |   |          |     |        |           |        |           |
| 104121   | WT 1064   |   |          |                             |          |                             |          |                             |          |  |          |                             |        |                             |        |                             |        |                             |        |            |        |          |        |          |        |          |        |            |        |                         |   |                          |        |                          |                              |                          |                              |                          |                              |                          |                              |                          |  |           |                           |                |                           |           |                           |           |                           |           |                           |  |        |            |          |            |        |             |        |            |          |            |        |            |        |            |          |            |        |            |  |   |          |     |        |           |        |           |
| 105121   | WT 1065   |   |          |                             |          |                             |          |                             |          |  |          |                             |        |                             |        |                             |        |                             |        |            |        |          |        |          |        |          |        |            |        |                         |   |                          |        |                          |                              |                          |                              |                          |                              |                          |                              |                          |  |           |                           |                |                           |           |                           |           |                           |           |                           |  |        |            |          |            |        |             |        |            |          |            |        |            |        |            |          |            |        |            |  |   |          |     |        |           |        |           |
| 106121   | WT 1070 $\varnothing$ 8   |   |          |                             |          |                             |          |                             |          |  |          |                             |        |                             |        |                             |        |                             |        |            |        |          |        |          |        |          |        |            |        |                         |   |                          |        |                          |                              |                          |                              |                          |                              |                          |                              |                          |  |           |                           |                |                           |           |                           |           |                           |           |                           |  |        |            |          |            |        |             |        |            |          |            |        |            |        |            |          |            |        |            |  |   |          |     |        |           |        |           |
| 107121   | WT 1071 $\varnothing$ 10  |   |          |                             |          |                             |          |                             |          |  |          |                             |        |                             |        |                             |        |                             |        |            |        |          |        |          |        |          |        |            |        |                         |   |                          |        |                          |                              |                          |                              |                          |                              |                          |                              |                          |  |           |                           |                |                           |           |                           |           |                           |           |                           |  |        |            |          |            |        |             |        |            |          |            |        |            |        |            |          |            |        |            |  |   |          |     |        |           |        |           |
| 108121   | WT 1072 $\varnothing$ 12  |   |          |                             |          |                             |          |                             |          |  |          |                             |        |                             |        |                             |        |                             |        |            |        |          |        |          |        |          |        |            |        |                         |   |                          |        |                          |                              |                          |                              |                          |                              |                          |                              |                          |  |           |                           |                |                           |           |                           |           |                           |           |                           |  |        |            |          |            |        |             |        |            |          |            |        |            |        |            |          |            |        |            |  |   |          |     |        |           |        |           |
| 109121   | WT 1073 $\varnothing$ 16  |   |          |                             |          |                             |          |                             |          |  |          |                             |        |                             |        |                             |        |                             |        |            |        |          |        |          |        |          |        |            |        |                         |   |                          |        |                          |                              |                          |                              |                          |                              |                          |                              |                          |  |           |                           |                |                           |           |                           |           |                           |           |                           |  |        |            |          |            |        |             |        |            |          |            |        |            |        |            |          |            |        |            |  |   |          |     |        |           |        |           |
| 112121   | WT 1076 $\varnothing$ 18  |   |          |                             |          |                             |          |                             |          |  |          |                             |        |                             |        |                             |        |                             |        |            |        |          |        |          |        |          |        |            |        |                         |   |                          |        |                          |                              |                          |                              |                          |                              |                          |                              |                          |  |           |                           |                |                           |           |                           |           |                           |           |                           |  |        |            |          |            |        |             |        |            |          |            |        |            |        |            |          |            |        |            |  |   |          |     |        |           |        |           |
| 110121   | WT 1074 $\varnothing$ 20  |   |          |                             |          |                             |          |                             |          |  |          |                             |        |                             |        |                             |        |                             |        |            |        |          |        |          |        |          |        |            |        |                         |   |                          |        |                          |                              |                          |                              |                          |                              |                          |                              |                          |  |           |                           |                |                           |           |                           |           |                           |           |                           |  |        |            |          |            |        |             |        |            |          |            |        |            |        |            |          |            |        |            |  |   |          |     |        |           |        |           |
| 111121   | WT 1075 $\varnothing$ 25  |   |          |                             |          |                             |          |                             |          |  |          |                             |        |                             |        |                             |        |                             |        |            |        |          |        |          |        |          |        |            |        |                         |   |                          |        |                          |                              |                          |                              |                          |                              |                          |                              |                          |  |           |                           |                |                           |           |                           |           |                           |           |                           |  |        |            |          |            |        |             |        |            |          |            |        |            |        |            |          |            |        |            |  |   |          |     |        |           |        |           |
| Art.-Nr.   | Typ   | R   |          |                             |          |                             |          |                             |          |  |          |                             |        |                             |        |                             |        |                             |        |            |        |          |        |          |        |          |        |            |        |                         |   |                          |        |                          |                              |                          |                              |                          |                              |                          |                              |                          |  |           |                           |                |                           |           |                           |           |                           |           |                           |  |        |            |          |            |        |             |        |            |          |            |        |            |        |            |          |            |        |            |  |   |          |     |        |           |        |           |
| 145120   | ZWM 1201  | 32  |          |                             |          |                             |          |                             |          |  |          |                             |        |                             |        |                             |        |                             |        |            |        |          |        |          |        |          |        |            |        |                         |   |                          |        |                          |                              |                          |                              |                          |                              |                          |                              |                          |  |           |                           |                |                           |           |                           |           |                           |           |                           |  |        |            |          |            |        |             |        |            |          |            |        |            |        |            |          |            |        |            |  |   |          |     |        |           |        |           |
| 146120   | ZWM 1202  | 40  |          |                             |          |                             |          |                             |          |  |          |                             |        |                             |        |                             |        |                             |        |            |        |          |        |          |        |          |        |            |        |                         |   |                          |        |                          |                              |                          |                              |                          |                              |                          |                              |                          |  |           |                           |                |                           |           |                           |           |                           |           |                           |  |        |            |          |            |        |             |        |            |          |            |        |            |        |            |          |            |        |            |  |   |          |     |        |           |        |           |
| 147120   | ZWM 1203  | 56  |          |                             |          |                             |          |                             |          |  |          |                             |        |                             |        |                             |        |                             |        |            |        |          |        |          |        |          |        |            |        |                         |   |                          |        |                          |                              |                          |                              |                          |                              |                          |                              |                          |  |           |                           |                |                           |           |                           |           |                           |           |                           |  |        |            |          |            |        |             |        |            |          |            |        |            |        |            |          |            |        |            |  |   |          |     |        |           |        |           |
| 150122   | ZWM 2203  | 65  |          |                             |          |                             |          |                             |          |  |          |                             |        |                             |        |                             |        |                             |        |            |        |          |        |          |        |          |        |            |        |                         |   |                          |        |                          |                              |                          |                              |                          |                              |                          |                              |                          |  |           |                           |                |                           |           |                           |           |                           |           |                           |  |        |            |          |            |        |             |        |            |          |            |        |            |        |            |          |            |        |            |  |   |          |     |        |           |        |           |
| 151122   | ZWM 2204/05   | 72,5  |          |                             |          |                             |          |                             |          |  |          |                             |        |                             |        |                             |        |                             |        |            |        |          |        |          |        |          |        |            |        |                         |   |                          |        |                          |                              |                          |                              |                          |                              |                          |                              |                          |  |           |                           |                |                           |           |                           |           |                           |           |                           |  |        |            |          |            |        |             |        |            |          |            |        |            |        |            |          |            |        |            |  |   |          |     |        |           |        |           |
| 141121   | WTM 1001  |   |          |                             |          |                             |          |                             |          |  |          |                             |        |                             |        |                             |        |                             |        |            |        |          |        |          |        |          |        |            |        |                         |   |                          |        |                          |                              |                          |                              |                          |                              |                          |                              |                          |  |           |                           |                |                           |           |                           |           |                           |           |                           |  |        |            |          |            |        |             |        |            |          |            |        |            |        |            |          |            |        |            |  |   |          |     |        |           |        |           |
| 141123   | WTM 2201  |   |          |                             |          |                             |          |                             |          |  |          |                             |        |                             |        |                             |        |                             |        |            |        |          |        |          |        |          |        |            |        |                         |   |                          |        |                          |                              |                          |                              |                          |                              |                          |                              |                          |  |           |                           |                |                           |           |                           |           |                           |           |                           |  |        |            |          |            |        |             |        |            |          |            |        |            |        |            |          |            |        |            |  |   |          |     |        |           |        |           |
| 142123   | WTM 2202  |   |          |                             |          |                             |          |                             |          |  |          |                             |        |                             |        |                             |        |                             |        |            |        |          |        |          |        |          |        |            |        |                         |   |                          |        |                          |                              |                          |                              |                          |                              |                          |                              |                          |  |           |                           |                |                           |           |                           |           |                           |           |                           |  |        |            |          |            |        |             |        |            |          |            |        |            |        |            |          |            |        |            |  |   |          |     |        |           |        |           |
| 143123   | WTM 2203  |   |          |                             |          |                             |          |                             |          |  |          |                             |        |                             |        |                             |        |                             |        |            |        |          |        |          |        |          |        |            |        |                         |   |                          |        |                          |                              |                          |                              |                          |                              |                          |                              |                          |  |           |                           |                |                           |           |                           |           |                           |           |                           |  |        |            |          |            |        |             |        |            |          |            |        |            |        |            |          |            |        |            |  |   |          |     |        |           |        |           |
| Art.-Nr.   | Typ   |   |          |                             |          |                             |          |                             |          |  |          |                             |        |                             |        |                             |        |                             |        |            |        |          |        |          |        |          |        |            |        |                         |   |                          |        |                          |                              |                          |                              |                          |                              |                          |                              |                          |  |           |                           |                |                           |           |                           |           |                           |           |                           |  |        |            |          |            |        |             |        |            |          |            |        |            |        |            |          |            |        |            |  |   |          |     |        |           |        |           |
| 207122   | ZWME 2220   |   |          |                             |          |                             |          |                             |          |  |          |                             |        |                             |        |                             |        |                             |        |            |        |          |        |          |        |          |        |            |        |                         |   |                          |        |                          |                              |                          |                              |                          |                              |                          |                              |                          |  |           |                           |                |                           |           |                           |           |                           |           |                           |  |        |            |          |            |        |             |        |            |          |            |        |            |        |            |          |            |        |            |  |   |          |     |        |           |        |           |
| 221128   | ZWME 2221   |   |          |                             |          |                             |          |                             |          |  |          |                             |        |                             |        |                             |        |                             |        |            |        |          |        |          |        |          |        |            |        |                         |   |                          |        |                          |                              |                          |                              |                          |                              |                          |                              |                          |  |           |                           |                |                           |           |                           |           |                           |           |                           |  |        |            |          |            |        |             |        |            |          |            |        |            |        |            |          |            |        |            |  |   |          |     |        |           |        |           |
| <p><b>Grundwerkzeughalter und Werkzeugträger zum Längsdrehen für Gildemeister + Pittler</b></p>   | <p><b>Grundwerkzeughalter und Werkzeugträger für Innenbearbeitung</b></p>   | <p><b>Unterbauleisten für schwere Einstechschieber für Schütze</b></p>  <table border="1"> <thead> <tr> <th>Art.-Nr.</th> <th>Typ</th> </tr> </thead> <tbody> <tr><td>208122</td><td>SD 32</td></tr> <tr><td>209122</td><td>SD 50</td></tr> <tr><td>210122</td><td>SD 63+80</td></tr> <tr><td>211122</td><td>SF 32-51</td></tr> <tr><td>212122</td><td>SF 63-81</td></tr> <tr><td>198122</td><td>AF 67</td></tr> </tbody> </table> | Art.-Nr. | Typ                         | 208122   | SD 32                       | 209122   | SD 50                       | 210122   | SD 63+80   | 211122   | SF 32-51                    | 212122 | SF 63-81                    | 198122 | AF 67                       |        |                             |        |            |        |          |        |          |        |          |        |            |        |                         |   |                          |        |                          |                              |                          |                              |                          |                              |                          |                              |                          |  |           |                           |                |                           |           |                           |           |                           |           |                           |  |        |            |          |            |        |             |        |            |          |            |        |            |        |            |          |            |        |            |  |   |          |     |        |           |        |           |
| Art.-Nr.   | Typ   |   |          |                             |          |                             |          |                             |          |  |          |                             |        |                             |        |                             |        |                             |        |            |        |          |        |          |        |          |        |            |        |                         |   |                          |        |                          |                              |                          |                              |                          |                              |                          |                              |                          |  |           |                           |                |                           |           |                           |           |                           |           |                           |  |        |            |          |            |        |             |        |            |          |            |        |            |        |            |          |            |        |            |  |   |          |     |        |           |        |           |
| 208122   | SD 32   |   |          |                             |          |                             |          |                             |          |  |          |                             |        |                             |        |                             |        |                             |        |            |        |          |        |          |        |          |        |            |        |                         |   |                          |        |                          |                              |                          |                              |                          |                              |                          |                              |                          |  |           |                           |                |                           |           |                           |           |                           |           |                           |  |        |            |          |            |        |             |        |            |          |            |        |            |        |            |          |            |        |            |  |   |          |     |        |           |        |           |
| 209122   | SD 50   |   |          |                             |          |                             |          |                             |          |  |          |                             |        |                             |        |                             |        |                             |        |            |        |          |        |          |        |          |        |            |        |                         |   |                          |        |                          |                              |                          |                              |                          |                              |                          |                              |                          |  |           |                           |                |                           |           |                           |           |                           |           |                           |  |        |            |          |            |        |             |        |            |          |            |        |            |        |            |          |            |        |            |  |   |          |     |        |           |        |           |
| 210122   | SD 63+80  |   |          |                             |          |                             |          |                             |          |  |          |                             |        |                             |        |                             |        |                             |        |            |        |          |        |          |        |          |        |            |        |                         |   |                          |        |                          |                              |                          |                              |                          |                              |                          |                              |                          |  |           |                           |                |                           |           |                           |           |                           |           |                           |  |        |            |          |            |        |             |        |            |          |            |        |            |        |            |          |            |        |            |  |   |          |     |        |           |        |           |
| 211122   | SF 32-51  |   |          |                             |          |                             |          |                             |          |  |          |                             |        |                             |        |                             |        |                             |        |            |        |          |        |          |        |          |        |            |        |                         |   |                          |        |                          |                              |                          |                              |                          |                              |                          |                              |                          |  |           |                           |                |                           |           |                           |           |                           |           |                           |  |        |            |          |            |        |             |        |            |          |            |        |            |        |            |          |            |        |            |  |   |          |     |        |           |        |           |
| 212122   | SF 63-81  |   |          |                             |          |                             |          |                             |          |  |          |                             |        |                             |        |                             |        |                             |        |            |        |          |        |          |        |          |        |            |        |                         |   |                          |        |                          |                              |                          |                              |                          |                              |                          |                              |                          |  |           |                           |                |                           |           |                           |           |                           |           |                           |  |        |            |          |            |        |             |        |            |          |            |        |            |        |            |          |            |        |            |  |   |          |     |        |           |        |           |
| 198122   | AF 67   |   |          |                             |          |                             |          |                             |          |  |          |                             |        |                             |        |                             |        |                             |        |            |        |          |        |          |        |          |        |            |        |                         |   |                          |        |                          |                              |                          |                              |                          |                              |                          |                              |                          |  |           |                           |                |                           |           |                           |           |                           |           |                           |  |        |            |          |            |        |             |        |            |          |            |        |            |        |            |          |            |        |            |  |   |          |     |        |           |        |           |
| <table border="1"> <thead> <tr> <th>Art.-Nr.</th> <th>Typ</th> </tr> </thead> <tbody> <tr><td>141120</td><td>ZWM 1009</td></tr> <tr><td>142120</td><td>ZWM 1010</td></tr> <tr><td>141122</td><td>ZWM 2011</td></tr> <tr><td>142122</td><td>ZWM 2011-8</td></tr> <tr><td>143122</td><td>ZWM 2012</td></tr> <tr><td>144122</td><td>ZWM 2013</td></tr> <tr><td>143120</td><td>ZWM 1110</td></tr> <tr><td>145122</td><td>ZWM 2111</td></tr> <tr><td>146122</td><td>ZWM 2112</td></tr> <tr><td>147122</td><td>ZWM 2113</td></tr> <tr><td>141121</td><td>WTM 1001</td></tr> <tr><td>141123</td><td>WTM 2201</td></tr> <tr><td>142123</td><td>WTM 2202</td></tr> <tr><td>143123</td><td>WTM 2203</td></tr> </tbody> </table>  | Art.-Nr.  | Typ   | 141120   | ZWM 1009                    | 142120   | ZWM 1010                    | 141122   | ZWM 2011                    | 142122   | ZWM 2011-8   | 143122   | ZWM 2012                    | 144122 | ZWM 2013                    | 143120 | ZWM 1110                    | 145122 | ZWM 2111                    | 146122 | ZWM 2112   | 147122 | ZWM 2113 | 141121 | WTM 1001 | 141123 | WTM 2201 | 142123 | WTM 2202   | 143123 | WTM 2203                | <table border="1"> <thead> <tr> <th>Art.-Nr.</th> <th>Typ</th> </tr> </thead> <tbody> <tr><td>155122</td><td>ZWM 2301 <math>\varnothing</math>40,00</td></tr> <tr><td>156122</td><td>ZWM 2302 <math>\varnothing</math>50,00</td></tr> <tr><td>157122</td><td>ZWM 2303 <math>\varnothing</math>60,00</td></tr> <tr><td>158122</td><td>ZWM 2304 <math>\varnothing</math>50,80</td></tr> <tr><td>146123</td><td>WTM 2300 <math>\varnothing</math>12</td></tr> <tr><td>147123</td><td>WTM 2301 <math>\varnothing</math>16</td></tr> <tr><td>148123</td><td>WTM 2302 <math>\varnothing</math>20</td></tr> <tr><td>149123</td><td>WTM 2303 <math>\varnothing</math>25</td></tr> <tr><td>150123</td><td>WTM 2304 <math>\varnothing</math>30</td></tr> <tr><td>151123</td><td>WTM 2305 <math>\varnothing</math>32</td></tr> </tbody> </table> | Art.-Nr.                 | Typ    | 155122                   | ZWM 2301 $\varnothing$ 40,00 | 156122                   | ZWM 2302 $\varnothing$ 50,00 | 157122                   | ZWM 2303 $\varnothing$ 60,00 | 158122                   | ZWM 2304 $\varnothing$ 50,80 | 146123                   | WTM 2300 $\varnothing$ 12  | 147123    | WTM 2301 $\varnothing$ 16 | 148123         | WTM 2302 $\varnothing$ 20 | 149123    | WTM 2303 $\varnothing$ 25 | 150123    | WTM 2304 $\varnothing$ 30 | 151123    | WTM 2305 $\varnothing$ 32 | <p><b>Grundwerkzeughalter für Seitenschlitten Gildemeister Nutenstein starr und schwenkbar</b></p>  |        |            |          |            |        |             |        |            |          |            |        |            |        |            |          |            |        |            |  |   |          |     |        |           |        |           |
| Art.-Nr.   | Typ   |   |          |                             |          |                             |          |                             |          |  |          |                             |        |                             |        |                             |        |                             |        |            |        |          |        |          |        |          |        |            |        |                         |   |                          |        |                          |                              |                          |                              |                          |                              |                          |                              |                          |  |           |                           |                |                           |           |                           |           |                           |           |                           |  |        |            |          |            |        |             |        |            |          |            |        |            |        |            |          |            |        |            |  |   |          |     |        |           |        |           |
| 141120   | ZWM 1009  |   |          |                             |          |                             |          |                             |          |  |          |                             |        |                             |        |                             |        |                             |        |            |        |          |        |          |        |          |        |            |        |                         |   |                          |        |                          |                              |                          |                              |                          |                              |                          |                              |                          |  |           |                           |                |                           |           |                           |           |                           |           |                           |  |        |            |          |            |        |             |        |            |          |            |        |            |        |            |          |            |        |            |  |   |          |     |        |           |        |           |
| 142120   | ZWM 1010  |   |          |                             |          |                             |          |                             |          |  |          |                             |        |                             |        |                             |        |                             |        |            |        |          |        |          |        |          |        |            |        |                         |   |                          |        |                          |                              |                          |                              |                          |                              |                          |                              |                          |  |           |                           |                |                           |           |                           |           |                           |           |                           |  |        |            |          |            |        |             |        |            |          |            |        |            |        |            |          |            |        |            |  |   |          |     |        |           |        |           |
| 141122   | ZWM 2011  |   |          |                             |          |                             |          |                             |          |  |          |                             |        |                             |        |                             |        |                             |        |            |        |          |        |          |        |          |        |            |        |                         |   |                          |        |                          |                              |                          |                              |                          |                              |                          |                              |                          |  |           |                           |                |                           |           |                           |           |                           |           |                           |  |        |            |          |            |        |             |        |            |          |            |        |            |        |            |          |            |        |            |  |   |          |     |        |           |        |           |
| 142122   | ZWM 2011-8  |   |          |                             |          |                             |          |                             |          |  |          |                             |        |                             |        |                             |        |                             |        |            |        |          |        |          |        |          |        |            |        |                         |   |                          |        |                          |                              |                          |                              |                          |                              |                          |                              |                          |  |           |                           |                |                           |           |                           |           |                           |           |                           |  |        |            |          |            |        |             |        |            |          |            |        |            |        |            |          |            |        |            |  |   |          |     |        |           |        |           |
| 143122   | ZWM 2012  |   |          |                             |          |                             |          |                             |          |  |          |                             |        |                             |        |                             |        |                             |        |            |        |          |        |          |        |          |        |            |        |                         |   |                          |        |                          |                              |                          |                              |                          |                              |                          |                              |                          |  |           |                           |                |                           |           |                           |           |                           |           |                           |  |        |            |          |            |        |             |        |            |          |            |        |            |        |            |          |            |        |            |  |   |          |     |        |           |        |           |
| 144122   | ZWM 2013  |   |          |                             |          |                             |          |                             |          |  |          |                             |        |                             |        |                             |        |                             |        |            |        |          |        |          |        |          |        |            |        |                         |   |                          |        |                          |                              |                          |                              |                          |                              |                          |                              |                          |  |           |                           |                |                           |           |                           |           |                           |           |                           |  |        |            |          |            |        |             |        |            |          |            |        |            |        |            |          |            |        |            |  |   |          |     |        |           |        |           |
| 143120   | ZWM 1110  |   |          |                             |          |                             |          |                             |          |  |          |                             |        |                             |        |                             |        |                             |        |            |        |          |        |          |        |          |        |            |        |                         |   |                          |        |                          |                              |                          |                              |                          |                              |                          |                              |                          |  |           |                           |                |                           |           |                           |           |                           |           |                           |  |        |            |          |            |        |             |        |            |          |            |        |            |        |            |          |            |        |            |  |   |          |     |        |           |        |           |
| 145122   | ZWM 2111  |   |          |                             |          |                             |          |                             |          |  |          |                             |        |                             |        |                             |        |                             |        |            |        |          |        |          |        |          |        |            |        |                         |   |                          |        |                          |                              |                          |                              |                          |                              |                          |                              |                          |  |           |                           |                |                           |           |                           |           |                           |           |                           |  |        |            |          |            |        |             |        |            |          |            |        |            |        |            |          |            |        |            |  |   |          |     |        |           |        |           |
| 146122   | ZWM 2112  |   |          |                             |          |                             |          |                             |          |  |          |                             |        |                             |        |                             |        |                             |        |            |        |          |        |          |        |          |        |            |        |                         |   |                          |        |                          |                              |                          |                              |                          |                              |                          |                              |                          |  |           |                           |                |                           |           |                           |           |                           |           |                           |  |        |            |          |            |        |             |        |            |          |            |        |            |        |            |          |            |        |            |  |   |          |     |        |           |        |           |
| 147122   | ZWM 2113  |   |          |                             |          |                             |          |                             |          |  |          |                             |        |                             |        |                             |        |                             |        |            |        |          |        |          |        |          |        |            |        |                         |   |                          |        |                          |                              |                          |                              |                          |                              |                          |                              |                          |  |           |                           |                |                           |           |                           |           |                           |           |                           |  |        |            |          |            |        |             |        |            |          |            |        |            |        |            |          |            |        |            |  |   |          |     |        |           |        |           |
| 141121   | WTM 1001  |   |          |                             |          |                             |          |                             |          |  |          |                             |        |                             |        |                             |        |                             |        |            |        |          |        |          |        |          |        |            |        |                         |   |                          |        |                          |                              |                          |                              |                          |                              |                          |                              |                          |  |           |                           |                |                           |           |                           |           |                           |           |                           |  |        |            |          |            |        |             |        |            |          |            |        |            |        |            |          |            |        |            |  |   |          |     |        |           |        |           |
| 141123   | WTM 2201  |   |          |                             |          |                             |          |                             |          |  |          |                             |        |                             |        |                             |        |                             |        |            |        |          |        |          |        |          |        |            |        |                         |   |                          |        |                          |                              |                          |                              |                          |                              |                          |                              |                          |  |           |                           |                |                           |           |                           |           |                           |           |                           |  |        |            |          |            |        |             |        |            |          |            |        |            |        |            |          |            |        |            |  |   |          |     |        |           |        |           |
| 142123   | WTM 2202  |   |          |                             |          |                             |          |                             |          |  |          |                             |        |                             |        |                             |        |                             |        |            |        |          |        |          |        |          |        |            |        |                         |   |                          |        |                          |                              |                          |                              |                          |                              |                          |                              |                          |  |           |                           |                |                           |           |                           |           |                           |           |                           |  |        |            |          |            |        |             |        |            |          |            |        |            |        |            |          |            |        |            |  |   |          |     |        |           |        |           |
| 143123   | WTM 2203  |   |          |                             |          |                             |          |                             |          |  |          |                             |        |                             |        |                             |        |                             |        |            |        |          |        |          |        |          |        |            |        |                         |   |                          |        |                          |                              |                          |                              |                          |                              |                          |                              |                          |  |           |                           |                |                           |           |                           |           |                           |           |                           |  |        |            |          |            |        |             |        |            |          |            |        |            |        |            |          |            |        |            |  |   |          |     |        |           |        |           |
| Art.-Nr.   | Typ   |   |          |                             |          |                             |          |                             |          |  |          |                             |        |                             |        |                             |        |                             |        |            |        |          |        |          |        |          |        |            |        |                         |   |                          |        |                          |                              |                          |                              |                          |                              |                          |                              |                          |  |           |                           |                |                           |           |                           |           |                           |           |                           |  |        |            |          |            |        |             |        |            |          |            |        |            |        |            |          |            |        |            |  |   |          |     |        |           |        |           |
| 155122   | ZWM 2301 $\varnothing$ 40,00  |   |          |                             |          |                             |          |                             |          |  |          |                             |        |                             |        |                             |        |                             |        |            |        |          |        |          |        |          |        |            |        |                         |   |                          |        |                          |                              |                          |                              |                          |                              |                          |                              |                          |  |           |                           |                |                           |           |                           |           |                           |           |                           |  |        |            |          |            |        |             |        |            |          |            |        |            |        |            |          |            |        |            |  |   |          |     |        |           |        |           |
| 156122   | ZWM 2302 $\varnothing$ 50,00  |   |          |                             |          |                             |          |                             |          |  |          |                             |        |                             |        |                             |        |                             |        |            |        |          |        |          |        |          |        |            |        |                         |   |                          |        |                          |                              |                          |                              |                          |                              |                          |                              |                          |  |           |                           |                |                           |           |                           |           |                           |           |                           |  |        |            |          |            |        |             |        |            |          |            |        |            |        |            |          |            |        |            |  |   |          |     |        |           |        |           |
| 157122   | ZWM 2303 $\varnothing$ 60,00  |   |          |                             |          |                             |          |                             |          |  |          |                             |        |                             |        |                             |        |                             |        |            |        |          |        |          |        |          |        |            |        |                         |   |                          |        |                          |                              |                          |                              |                          |                              |                          |                              |                          |  |           |                           |                |                           |           |                           |           |                           |           |                           |  |        |            |          |            |        |             |        |            |          |            |        |            |        |            |          |            |        |            |  |   |          |     |        |           |        |           |
| 158122   | ZWM 2304 $\varnothing$ 50,80  |   |          |                             |          |                             |          |                             |          |  |          |                             |        |                             |        |                             |        |                             |        |            |        |          |        |          |        |          |        |            |        |                         |   |                          |        |                          |                              |                          |                              |                          |                              |                          |                              |                          |  |           |                           |                |                           |           |                           |           |                           |           |                           |  |        |            |          |            |        |             |        |            |          |            |        |            |        |            |          |            |        |            |  |   |          |     |        |           |        |           |
| 146123   | WTM 2300 $\varnothing$ 12   |   |          |                             |          |                             |          |                             |          |  |          |                             |        |                             |        |                             |        |                             |        |            |        |          |        |          |        |          |        |            |        |                         |   |                          |        |                          |                              |                          |                              |                          |                              |                          |                              |                          |  |           |                           |                |                           |           |                           |           |                           |           |                           |  |        |            |          |            |        |             |        |            |          |            |        |            |        |            |          |            |        |            |  |   |          |     |        |           |        |           |
| 147123   | WTM 2301 $\varnothing$ 16   |   |          |                             |          |                             |          |                             |          |  |          |                             |        |                             |        |                             |        |                             |        |            |        |          |        |          |        |          |        |            |        |                         |   |                          |        |                          |                              |                          |                              |                          |                              |                          |                              |                          |  |           |                           |                |                           |           |                           |           |                           |           |                           |  |        |            |          |            |        |             |        |            |          |            |        |            |        |            |          |            |        |            |  |   |          |     |        |           |        |           |
| 148123   | WTM 2302 $\varnothing$ 20   |   |          |                             |          |                             |          |                             |          |  |          |                             |        |                             |        |                             |        |                             |        |            |        |          |        |          |        |          |        |            |        |                         |   |                          |        |                          |                              |                          |                              |                          |                              |                          |                              |                          |  |           |                           |                |                           |           |                           |           |                           |           |                           |  |        |            |          |            |        |             |        |            |          |            |        |            |        |            |          |            |        |            |  |   |          |     |        |           |        |           |
| 149123   | WTM 2303 $\varnothing$ 25   |   |          |                             |          |                             |          |                             |          |  |          |                             |        |                             |        |                             |        |                             |        |            |        |          |        |          |        |          |        |            |        |                         |   |                          |        |                          |                              |                          |                              |                          |                              |                          |                              |                          |  |           |                           |                |                           |           |                           |           |                           |           |                           |  |        |            |          |            |        |             |        |            |          |            |        |            |        |            |          |            |        |            |  |   |          |     |        |           |        |           |
| 150123   | WTM 2304 $\varnothing$ 30   |   |          |                             |          |                             |          |                             |          |  |          |                             |        |                             |        |                             |        |                             |        |            |        |          |        |          |        |          |        |            |        |                         |   |                          |        |                          |                              |                          |                              |                          |                              |                          |                              |                          |  |           |                           |                |                           |           |                           |           |                           |           |                           |  |        |            |          |            |        |             |        |            |          |            |        |            |        |            |          |            |        |            |  |   |          |     |        |           |        |           |
| 151123   | WTM 2305 $\varnothing$ 32   |   |          |                             |          |                             |          |                             |          |  |          |                             |        |                             |        |                             |        |                             |        |            |        |          |        |          |        |          |        |            |        |                         |   |                          |        |                          |                              |                          |                              |                          |                              |                          |                              |                          |  |           |                           |                |                           |           |                           |           |                           |           |                           |  |        |            |          |            |        |             |        |            |          |            |        |            |        |            |          |            |        |            |  |   |          |     |        |           |        |           |
|  | <p><b>Einstechschieber mit zylindrischer Aufnahme</b></p>  <table border="1"> <thead> <tr> <th>Art.-Nr.</th> <th>Typ</th> </tr> </thead> <tbody> <tr><td>149120</td><td>ZWV 1111</td></tr> <tr><td>204122</td><td>ZWV 2112</td></tr> <tr><td>205122</td><td>ZWV 2114</td></tr> </tbody> </table> | Art.-Nr.  | Typ      | 149120                      | ZWV 1111 | 204122                      | ZWV 2112 | 205122                      | ZWV 2114 | <table border="1"> <thead> <tr> <th>Art.-Nr.</th> <th>Typ</th> </tr> </thead> <tbody> <tr><td>160122</td><td>ZWM 2030</td></tr> <tr><td>161122</td><td>ZWM 2031</td></tr> <tr><td>178122</td><td>ZWM 2030-S</td></tr> <tr><td>248122</td><td>ZWM 2031-S</td></tr> <tr><td>141124</td><td>ZWM 3030</td></tr> <tr><td>142124</td><td>ZWM 3031</td></tr> <tr><td>143124</td><td>ZWM 3032</td></tr> <tr><td>155124</td><td>ZWM 3030-S</td></tr> <tr><td>166124</td><td>ZWM 3031-S</td></tr> <tr><td>162122</td><td>ZWM 2040</td></tr> <tr><td>163122</td><td>ZWM 2041</td></tr> <tr><td>182122</td><td>ZWM 2040-S</td></tr> <tr><td>249122</td><td>ZWM 2041-S</td></tr> <tr><td>159124</td><td>ZWM 3040</td></tr> <tr><td>101130</td><td>N 2030-16</td></tr> <tr><td>119130</td><td>N 2031-18</td></tr> <tr><td>123130</td><td>N 2041/2241-18</td></tr> <tr><td>121130</td><td>N 3030-18</td></tr> <tr><td>104130</td><td>N 3031-20</td></tr> <tr><td>105130</td><td>N 3032-22</td></tr> <tr><td>181130</td><td>NS 2030-16</td></tr> <tr><td>199130</td><td>NS 2031-18</td></tr> <tr><td>186130</td><td>NS 2040-16</td></tr> <tr><td>203130</td><td>NS 2041-18</td></tr> <tr><td>201130</td><td>NS 3030-18</td></tr> <tr><td>205130</td><td>NS 3040-18</td></tr> <tr><td>184130</td><td>NS 3031-20</td></tr> <tr><td>188130</td><td>NS 3041-20</td></tr> <tr><td>185130</td><td>NS 3032-22</td></tr> <tr><td>189130</td><td>NS 3042-22</td></tr> </tbody> </table> | Art.-Nr. | Typ                         | 160122 | ZWM 2030                    | 161122 | ZWM 2031                    | 178122 | ZWM 2030-S                  | 248122 | ZWM 2031-S | 141124 | ZWM 3030 | 142124 | ZWM 3031 | 143124 | ZWM 3032 | 155124 | ZWM 3030-S | 166124 | ZWM 3031-S              | 162122  | ZWM 2040                 | 163122 | ZWM 2041                 | 182122                       | ZWM 2040-S               | 249122                       | ZWM 2041-S               | 159124                       | ZWM 3040                 | 101130                       | N 2030-16                | 119130   | N 2031-18 | 123130                    | N 2041/2241-18 | 121130                    | N 3030-18 | 104130                    | N 3031-20 | 105130                    | N 3032-22 | 181130                    | NS 2030-16   | 199130 | NS 2031-18 | 186130   | NS 2040-16 | 203130 | NS 2041-18  | 201130 | NS 3030-18 | 205130   | NS 3040-18 | 184130 | NS 3031-20 | 188130 | NS 3041-20 | 185130   | NS 3032-22 | 189130 | NS 3042-22 |  |   |          |     |        |           |        |           |
| Art.-Nr.   | Typ   |   |          |                             |          |                             |          |                             |          |  |          |                             |        |                             |        |                             |        |                             |        |            |        |          |        |          |        |          |        |            |        |                         |   |                          |        |                          |                              |                          |                              |                          |                              |                          |                              |                          |  |           |                           |                |                           |           |                           |           |                           |           |                           |  |        |            |          |            |        |             |        |            |          |            |        |            |        |            |          |            |        |            |  |   |          |     |        |           |        |           |
| 149120   | ZWV 1111  |   |          |                             |          |                             |          |                             |          |  |          |                             |        |                             |        |                             |        |                             |        |            |        |          |        |          |        |          |        |            |        |                         |   |                          |        |                          |                              |                          |                              |                          |                              |                          |                              |                          |  |           |                           |                |                           |           |                           |           |                           |           |                           |  |        |            |          |            |        |             |        |            |          |            |        |            |        |            |          |            |        |            |  |   |          |     |        |           |        |           |
| 204122   | ZWV 2112  |   |          |                             |          |                             |          |                             |          |  |          |                             |        |                             |        |                             |        |                             |        |            |        |          |        |          |        |          |        |            |        |                         |   |                          |        |                          |                              |                          |                              |                          |                              |                          |                              |                          |  |           |                           |                |                           |           |                           |           |                           |           |                           |  |        |            |          |            |        |             |        |            |          |            |        |            |        |            |          |            |        |            |  |   |          |     |        |           |        |           |
| 205122   | ZWV 2114  |   |          |                             |          |                             |          |                             |          |  |          |                             |        |                             |        |                             |        |                             |        |            |        |          |        |          |        |          |        |            |        |                         |   |                          |        |                          |                              |                          |                              |                          |                              |                          |                              |                          |  |           |                           |                |                           |           |                           |           |                           |           |                           |  |        |            |          |            |        |             |        |            |          |            |        |            |        |            |          |            |        |            |  |   |          |     |        |           |        |           |
| Art.-Nr.   | Typ   |   |          |                             |          |                             |          |                             |          |  |          |                             |        |                             |        |                             |        |                             |        |            |        |          |        |          |        |          |        |            |        |                         |   |                          |        |                          |                              |                          |                              |                          |                              |                          |                              |                          |  |           |                           |                |                           |           |                           |           |                           |           |                           |  |        |            |          |            |        |             |        |            |          |            |        |            |        |            |          |            |        |            |  |   |          |     |        |           |        |           |
| 160122   | ZWM 2030  |   |          |                             |          |                             |          |                             |          |  |          |                             |        |                             |        |                             |        |                             |        |            |        |          |        |          |        |          |        |            |        |                         |   |                          |        |                          |                              |                          |                              |                          |                              |                          |                              |                          |  |           |                           |                |                           |           |                           |           |                           |           |                           |  |        |            |          |            |        |             |        |            |          |            |        |            |        |            |          |            |        |            |  |   |          |     |        |           |        |           |
| 161122   | ZWM 2031  |   |          |                             |          |                             |          |                             |          |  |          |                             |        |                             |        |                             |        |                             |        |            |        |          |        |          |        |          |        |            |        |                         |   |                          |        |                          |                              |                          |                              |                          |                              |                          |                              |                          |  |           |                           |                |                           |           |                           |           |                           |           |                           |  |        |            |          |            |        |             |        |            |          |            |        |            |        |            |          |            |        |            |  |   |          |     |        |           |        |           |
| 178122   | ZWM 2030-S  |   |          |                             |          |                             |          |                             |          |  |          |                             |        |                             |        |                             |        |                             |        |            |        |          |        |          |        |          |        |            |        |                         |   |                          |        |                          |                              |                          |                              |                          |                              |                          |                              |                          |  |           |                           |                |                           |           |                           |           |                           |           |                           |  |        |            |          |            |        |             |        |            |          |            |        |            |        |            |          |            |        |            |  |   |          |     |        |           |        |           |
| 248122   | ZWM 2031-S  |   |          |                             |          |                             |          |                             |          |  |          |                             |        |                             |        |                             |        |                             |        |            |        |          |        |          |        |          |        |            |        |                         |   |                          |        |                          |                              |                          |                              |                          |                              |                          |                              |                          |  |           |                           |                |                           |           |                           |           |                           |           |                           |  |        |            |          |            |        |             |        |            |          |            |        |            |        |            |          |            |        |            |  |   |          |     |        |           |        |           |
| 141124   | ZWM 3030  |   |          |                             |          |                             |          |                             |          |  |          |                             |        |                             |        |                             |        |                             |        |            |        |          |        |          |        |          |        |            |        |                         |   |                          |        |                          |                              |                          |                              |                          |                              |                          |                              |                          |  |           |                           |                |                           |           |                           |           |                           |           |                           |  |        |            |          |            |        |             |        |            |          |            |        |            |        |            |          |            |        |            |  |   |          |     |        |           |        |           |
| 142124   | ZWM 3031  |   |          |                             |          |                             |          |                             |          |  |          |                             |        |                             |        |                             |        |                             |        |            |        |          |        |          |        |          |        |            |        |                         |   |                          |        |                          |                              |                          |                              |                          |                              |                          |                              |                          |  |           |                           |                |                           |           |                           |           |                           |           |                           |  |        |            |          |            |        |             |        |            |          |            |        |            |        |            |          |            |        |            |  |   |          |     |        |           |        |           |
| 143124   | ZWM 3032  |   |          |                             |          |                             |          |                             |          |  |          |                             |        |                             |        |                             |        |                             |        |            |        |          |        |          |        |          |        |            |        |                         |   |                          |        |                          |                              |                          |                              |                          |                              |                          |                              |                          |  |           |                           |                |                           |           |                           |           |                           |           |                           |  |        |            |          |            |        |             |        |            |          |            |        |            |        |            |          |            |        |            |  |   |          |     |        |           |        |           |
| 155124   | ZWM 3030-S  |   |          |                             |          |                             |          |                             |          |  |          |                             |        |                             |        |                             |        |                             |        |            |        |          |        |          |        |          |        |            |        |                         |   |                          |        |                          |                              |                          |                              |                          |                              |                          |                              |                          |  |           |                           |                |                           |           |                           |           |                           |           |                           |  |        |            |          |            |        |             |        |            |          |            |        |            |        |            |          |            |        |            |  |   |          |     |        |           |        |           |
| 166124   | ZWM 3031-S  |   |          |                             |          |                             |          |                             |          |  |          |                             |        |                             |        |                             |        |                             |        |            |        |          |        |          |        |          |        |            |        |                         |   |                          |        |                          |                              |                          |                              |                          |                              |                          |                              |                          |  |           |                           |                |                           |           |                           |           |                           |           |                           |  |        |            |          |            |        |             |        |            |          |            |        |            |        |            |          |            |        |            |  |   |          |     |        |           |        |           |
| 162122   | ZWM 2040  |   |          |                             |          |                             |          |                             |          |  |          |                             |        |                             |        |                             |        |                             |        |            |        |          |        |          |        |          |        |            |        |                         |   |                          |        |                          |                              |                          |                              |                          |                              |                          |                              |                          |  |           |                           |                |                           |           |                           |           |                           |           |                           |  |        |            |          |            |        |             |        |            |          |            |        |            |        |            |          |            |        |            |  |   |          |     |        |           |        |           |
| 163122   | ZWM 2041  |   |          |                             |          |                             |          |                             |          |  |          |                             |        |                             |        |                             |        |                             |        |            |        |          |        |          |        |          |        |            |        |                         |   |                          |        |                          |                              |                          |                              |                          |                              |                          |                              |                          |  |           |                           |                |                           |           |                           |           |                           |           |                           |  |        |            |          |            |        |             |        |            |          |            |        |            |        |            |          |            |        |            |  |   |          |     |        |           |        |           |
| 182122   | ZWM 2040-S  |   |          |                             |          |                             |          |                             |          |  |          |                             |        |                             |        |                             |        |                             |        |            |        |          |        |          |        |          |        |            |        |                         |   |                          |        |                          |                              |                          |                              |                          |                              |                          |                              |                          |  |           |                           |                |                           |           |                           |           |                           |           |                           |  |        |            |          |            |        |             |        |            |          |            |        |            |        |            |          |            |        |            |  |   |          |     |        |           |        |           |
| 249122   | ZWM 2041-S  |   |          |                             |          |                             |          |                             |          |  |          |                             |        |                             |        |                             |        |                             |        |            |        |          |        |          |        |          |        |            |        |                         |   |                          |        |                          |                              |                          |                              |                          |                              |                          |                              |                          |  |           |                           |                |                           |           |                           |           |                           |           |                           |  |        |            |          |            |        |             |        |            |          |            |        |            |        |            |          |            |        |            |  |   |          |     |        |           |        |           |
| 159124   | ZWM 3040  |   |          |                             |          |                             |          |                             |          |  |          |                             |        |                             |        |                             |        |                             |        |            |        |          |        |          |        |          |        |            |        |                         |   |                          |        |                          |                              |                          |                              |                          |                              |                          |                              |                          |  |           |                           |                |                           |           |                           |           |                           |           |                           |  |        |            |          |            |        |             |        |            |          |            |        |            |        |            |          |            |        |            |  |   |          |     |        |           |        |           |
| 101130   | N 2030-16   |   |          |                             |          |                             |          |                             |          |  |          |                             |        |                             |        |                             |        |                             |        |            |        |          |        |          |        |          |        |            |        |                         |   |                          |        |                          |                              |                          |                              |                          |                              |                          |                              |                          |  |           |                           |                |                           |           |                           |           |                           |           |                           |  |        |            |          |            |        |             |        |            |          |            |        |            |        |            |          |            |        |            |  |   |          |     |        |           |        |           |
| 119130   | N 2031-18   |   |          |                             |          |                             |          |                             |          |  |          |                             |        |                             |        |                             |        |                             |        |            |        |          |        |          |        |          |        |            |        |                         |   |                          |        |                          |                              |                          |                              |                          |                              |                          |                              |                          |  |           |                           |                |                           |           |                           |           |                           |           |                           |  |        |            |          |            |        |             |        |            |          |            |        |            |        |            |          |            |        |            |  |   |          |     |        |           |        |           |
| 123130   | N 2041/2241-18  |   |          |                             |          |                             |          |                             |          |  |          |                             |        |                             |        |                             |        |                             |        |            |        |          |        |          |        |          |        |            |        |                         |   |                          |        |                          |                              |                          |                              |                          |                              |                          |                              |                          |  |           |                           |                |                           |           |                           |           |                           |           |                           |  |        |            |          |            |        |             |        |            |          |            |        |            |        |            |          |            |        |            |  |   |          |     |        |           |        |           |
| 121130   | N 3030-18   |   |          |                             |          |                             |          |                             |          |  |          |                             |        |                             |        |                             |        |                             |        |            |        |          |        |          |        |          |        |            |        |                         |   |                          |        |                          |                              |                          |                              |                          |                              |                          |                              |                          |  |           |                           |                |                           |           |                           |           |                           |           |                           |  |        |            |          |            |        |             |        |            |          |            |        |            |        |            |          |            |        |            |  |   |          |     |        |           |        |           |
| 104130   | N 3031-20   |   |          |                             |          |                             |          |                             |          |  |          |                             |        |                             |        |                             |        |                             |        |            |        |          |        |          |        |          |        |            |        |                         |   |                          |        |                          |                              |                          |                              |                          |                              |                          |                              |                          |  |           |                           |                |                           |           |                           |           |                           |           |                           |  |        |            |          |            |        |             |        |            |          |            |        |            |        |            |          |            |        |            |  |   |          |     |        |           |        |           |
| 105130   | N 3032-22   |   |          |                             |          |                             |          |                             |          |  |          |                             |        |                             |        |                             |        |                             |        |            |        |          |        |          |        |          |        |            |        |                         |   |                          |        |                          |                              |                          |                              |                          |                              |                          |                              |                          |  |           |                           |                |                           |           |                           |           |                           |           |                           |  |        |            |          |            |        |             |        |            |          |            |        |            |        |            |          |            |        |            |  |   |          |     |        |           |        |           |
| 181130   | NS 2030-16  |   |          |                             |          |                             |          |                             |          |  |          |                             |        |                             |        |                             |        |                             |        |            |        |          |        |          |        |          |        |            |        |                         |   |                          |        |                          |                              |                          |                              |                          |                              |                          |                              |                          |  |           |                           |                |                           |           |                           |           |                           |           |                           |  |        |            |          |            |        |             |        |            |          |            |        |            |        |            |          |            |        |            |  |   |          |     |        |           |        |           |
| 199130   | NS 2031-18  |   |          |                             |          |                             |          |                             |          |  |          |                             |        |                             |        |                             |        |                             |        |            |        |          |        |          |        |          |        |            |        |                         |   |                          |        |                          |                              |                          |                              |                          |                              |                          |                              |                          |  |           |                           |                |                           |           |                           |           |                           |           |                           |  |        |            |          |            |        |             |        |            |          |            |        |            |        |            |          |            |        |            |  |   |          |     |        |           |        |           |
| 186130   | NS 2040-16  |   |          |                             |          |                             |          |                             |          |  |          |                             |        |                             |        |                             |        |                             |        |            |        |          |        |          |        |          |        |            |        |                         |   |                          |        |                          |                              |                          |                              |                          |                              |                          |                              |                          |  |           |                           |                |                           |           |                           |           |                           |           |                           |  |        |            |          |            |        |             |        |            |          |            |        |            |        |            |          |            |        |            |  |   |          |     |        |           |        |           |
| 203130   | NS 2041-18  |   |          |                             |          |                             |          |                             |          |  |          |                             |        |                             |        |                             |        |                             |        |            |        |          |        |          |        |          |        |            |        |                         |   |                          |        |                          |                              |                          |                              |                          |                              |                          |                              |                          |  |           |                           |                |                           |           |                           |           |                           |           |                           |  |        |            |          |            |        |             |        |            |          |            |        |            |        |            |          |            |        |            |  |   |          |     |        |           |        |           |
| 201130   | NS 3030-18  |   |          |                             |          |                             |          |                             |          |  |          |                             |        |                             |        |                             |        |                             |        |            |        |          |        |          |        |          |        |            |        |                         |   |                          |        |                          |                              |                          |                              |                          |                              |                          |                              |                          |  |           |                           |                |                           |           |                           |           |                           |           |                           |  |        |            |          |            |        |             |        |            |          |            |        |            |        |            |          |            |        |            |  |   |          |     |        |           |        |           |
| 205130   | NS 3040-18  |   |          |                             |          |                             |          |                             |          |  |          |                             |        |                             |        |                             |        |                             |        |            |        |          |        |          |        |          |        |            |        |                         |   |                          |        |                          |                              |                          |                              |                          |                              |                          |                              |                          |  |           |                           |                |                           |           |                           |           |                           |           |                           |  |        |            |          |            |        |             |        |            |          |            |        |            |        |            |          |            |        |            |  |   |          |     |        |           |        |           |
| 184130   | NS 3031-20  |   |          |                             |          |                             |          |                             |          |  |          |                             |        |                             |        |                             |        |                             |        |            |        |          |        |          |        |          |        |            |        |                         |   |                          |        |                          |                              |                          |                              |                          |                              |                          |                              |                          |  |           |                           |                |                           |           |                           |           |                           |           |                           |  |        |            |          |            |        |             |        |            |          |            |        |            |        |            |          |            |        |            |  |   |          |     |        |           |        |           |
| 188130   | NS 3041-20  |   |          |                             |          |                             |          |                             |          |  |          |                             |        |                             |        |                             |        |                             |        |            |        |          |        |          |        |          |        |            |        |                         |   |                          |        |                          |                              |                          |                              |                          |                              |                          |                              |                          |  |           |                           |                |                           |           |                           |           |                           |           |                           |  |        |            |          |            |        |             |        |            |          |            |        |            |        |            |          |            |        |            |  |   |          |     |        |           |        |           |
| 185130   | NS 3032-22  |   |          |                             |          |                             |          |                             |          |  |          |                             |        |                             |        |                             |        |                             |        |            |        |          |        |          |        |          |        |            |        |                         |   |                          |        |                          |                              |                          |                              |                          |                              |                          |                              |                          |  |           |                           |                |                           |           |                           |           |                           |           |                           |  |        |            |          |            |        |             |        |            |          |            |        |            |        |            |          |            |        |            |  |   |          |     |        |           |        |           |
| 189130   | NS 3042-22  |   |          |                             |          |                             |          |                             |          |  |          |                             |        |                             |        |                             |        |                             |        |            |        |          |        |          |        |          |        |            |        |                         |   |                          |        |                          |                              |                          |                              |                          |                              |                          |                              |                          |  |           |                           |                |                           |           |                           |           |                           |           |                           |  |        |            |          |            |        |             |        |            |          |            |        |            |        |            |          |            |        |            |  |   |          |     |        |           |        |           |
|  | <p><b>Einstechschieber 45° mit zylindrischer Aufnahme</b></p>  <table border="1"> <thead> <tr> <th>Art.-Nr.</th> <th>Typ</th> </tr> </thead> <tbody> <tr><td>215122</td><td>ZWV 2915</td></tr> <tr><td>216122</td><td>ZWV 2916</td></tr> </tbody> </table>                                      | Art.-Nr.  | Typ      | 215122                      | ZWV 2915 | 216122                      | ZWV 2916 |                             |          |  |          |                             |        |                             |        |                             |        |                             |        |            |        |          |        |          |        |          |        |            |        |                         |   |                          |        |                          |                              |                          |                              |                          |                              |                          |                              |                          |  |           |                           |                |                           |           |                           |           |                           |           |                           |  |        |            |          |            |        |             |        |            |          |            |        |            |        |            |          |            |        |            |  |   |          |     |        |           |        |           |
| Art.-Nr.   | Typ   |   |          |                             |          |                             |          |                             |          |  |          |                             |        |                             |        |                             |        |                             |        |            |        |          |        |          |        |          |        |            |        |                         |   |                          |        |                          |                              |                          |                              |                          |                              |                          |                              |                          |  |           |                           |                |                           |           |                           |           |                           |           |                           |  |        |            |          |            |        |             |        |            |          |            |        |            |        |            |          |            |        |            |  |   |          |     |        |           |        |           |
| 215122   | ZWV 2915  |   |          |                             |          |                             |          |                             |          |  |          |                             |        |                             |        |                             |        |                             |        |            |        |          |        |          |        |          |        |            |        |                         |   |                          |        |                          |                              |                          |                              |                          |                              |                          |                              |                          |  |           |                           |                |                           |           |                           |           |                           |           |                           |  |        |            |          |            |        |             |        |            |          |            |        |            |        |            |          |            |        |            |  |   |          |     |        |           |        |           |
| 216122   | ZWV 2916  |   |          |                             |          |                             |          |                             |          |  |          |                             |        |                             |        |                             |        |                             |        |            |        |          |        |          |        |          |        |            |        |                         |   |                          |        |                          |                              |                          |                              |                          |                              |                          |                              |                          |  |           |                           |                |                           |           |                           |           |                           |           |                           |  |        |            |          |            |        |             |        |            |          |            |        |            |        |            |          |            |        |            |  |   |          |     |        |           |        |           |

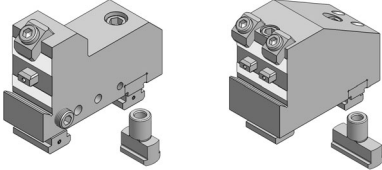
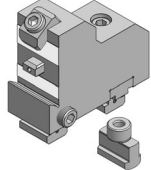
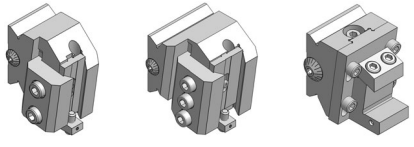
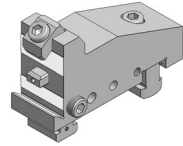
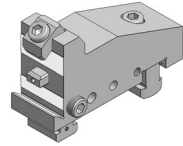
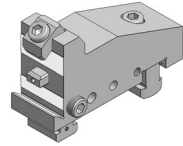
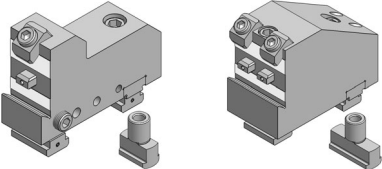
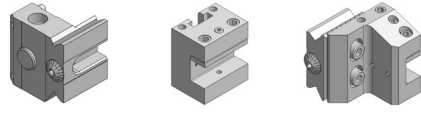
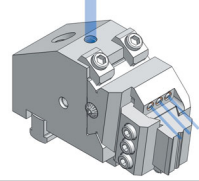
| <p><b>Grundwerkzeughalter für Seitenschlitten<br/>Pittler - Nutenstein starr und schwenkbar</b></p>    | <p><b>Grundwerkzeughalter für Seitenschlitten<br/>ZPS SAY incl. schwenkbarem Nutenstein</b></p>    | <p><b>Werkzeugträger für Flachformmeissel</b></p>  |        |          |         |          |         |          |         |          |         |          |         |            |         |          |         |          |         |          |         |          |         |          |         |        |         |              |         |              |         |              |         |              |         |               |         |               |         |               |         |               |         |               |        |               |           |               |           |               |   |          |           |        |           |           |             |        |          |           |          |   |          |        |          |             |          |             |          |             |        |   |        |   |        |             |     |        |          |             |          |   |          |             |        |             |        |             |           |             |        |               |        |             |        |          |        |          |        |            |        |          |        |            |        |          |        |          |        |          |        |            |        |          |        |          |        |          |        |            |        |          |        |            |        |          |  |  |        |          |        |          |
|---|---|---|--------|----------|---------|----------|---------|----------|---------|----------|---------|----------|---------|------------|---------|----------|---------|----------|---------|----------|---------|----------|---------|----------|---------|--------|---------|--------------|---------|--------------|---------|--------------|---------|--------------|---------|---------------|---------|---------------|---------|---------------|---------|---------------|---------|---------------|--------|---------------|-----------|---------------|-----------|---------------|---|----------|-----------|--------|-----------|-----------|-------------|--------|----------|-----------|----------|---|----------|--------|----------|-------------|----------|-------------|----------|-------------|--------|---|--------|---|--------|-------------|-----|--------|----------|-------------|----------|---|----------|-------------|--------|-------------|--------|-------------|-----------|-------------|--------|---------------|--------|-------------|--------|----------|--------|----------|--------|------------|--------|----------|--------|------------|--------|----------|--------|----------|--------|----------|--------|------------|--------|----------|--------|----------|--------|----------|--------|------------|--------|----------|--------|------------|--------|----------|--|--|--------|----------|--------|----------|
| <table border="1"> <thead> <tr> <th>Art.-Nr.</th> <th>Typ</th> </tr> </thead> <tbody> <tr><td>164122</td><td>ZWM 2130</td></tr> <tr><td>165122</td><td>ZWM 2131</td></tr> <tr><td>146124</td><td>ZWM 3130</td></tr> <tr><td>147124</td><td>ZWM 3131</td></tr> <tr><td>148124</td><td>ZWM 3132</td></tr> <tr><td>157124</td><td>ZWM 3130-S</td></tr> <tr><td>166122</td><td>ZWM 2140</td></tr> <tr><td>167122</td><td>ZWM 2141</td></tr> <tr><td>161124</td><td>ZWM 3140</td></tr> <tr><td>149124</td><td>ZWM 3141</td></tr> <tr><td>150124</td><td>ZWM 3142</td></tr> <tr><td colspan="2"> </td></tr> <tr><td>110130</td><td>N 2130-15,87</td></tr> <tr><td>111130</td><td>N 2131-19,05</td></tr> <tr><td>112130</td><td>N 3130-19,05</td></tr> <tr><td>114130</td><td>N 3132-22,22</td></tr> <tr><td>190130</td><td>NS 2130-15,87</td></tr> <tr><td>191130</td><td>NS 2131-19,05</td></tr> <tr><td>192130</td><td>NS 3130-19,05</td></tr> <tr><td>194130</td><td>NS 3132-22,22</td></tr> <tr><td>195130</td><td>NS 2140-15,87</td></tr> <tr><td>196130</td><td>NS 2141-19,05</td></tr> <tr><td>197130</td><td>NS 3141-19,05</td></tr> <tr><td>198130</td><td>NS 3142-22,22</td></tr> </tbody> </table> | Art.-Nr.  | Typ   | 164122 | ZWM 2130 | 165122  | ZWM 2131 | 146124  | ZWM 3130 | 147124  | ZWM 3131 | 148124  | ZWM 3132 | 157124  | ZWM 3130-S | 166122  | ZWM 2140 | 167122  | ZWM 2141 | 161124  | ZWM 3140 | 149124  | ZWM 3141 | 150124  | ZWM 3142 |         |        | 110130  | N 2130-15,87 | 111130  | N 2131-19,05 | 112130  | N 3130-19,05 | 114130  | N 3132-22,22 | 190130  | NS 2130-15,87 | 191130  | NS 2131-19,05 | 192130  | NS 3130-19,05 | 194130  | NS 3132-22,22 | 195130  | NS 2140-15,87 | 196130 | NS 2141-19,05 | 197130    | NS 3141-19,05 | 198130    | NS 3142-22,22 | <table border="1"> <thead> <tr> <th>Art.-Nr.</th> <th>Typ</th> </tr> </thead> <tbody> <tr><td>228122</td><td>SAY 32-6</td></tr> <tr><td>228122-iK</td><td>SAY 32-6-iK</td></tr> <tr><td>238122</td><td>SAY 32-6</td></tr> <tr><td>229122</td><td>SAY 32-6</td></tr> <tr><td>230122</td><td>SAY 32-6</td></tr> <tr><td>226122</td><td>SAY 40-6</td></tr> <tr><td>227122</td><td>SAY 40-6</td></tr> <tr><td>231122</td><td>SAY 40-6</td></tr> <tr><td colspan="2"> </td></tr> <tr> <td colspan="2"><b>Grundwerkzeughalter für Seitenschlitten<br/>INDEX MS25<br/>incl. schwenkbarem Nutenstein</b></td> </tr> <tr> <td colspan="2" style="text-align: center;">  </td> </tr> <tr> <th>Art.-Nr.</th> <th>Typ</th> </tr> <tr><td>185122</td><td>ZWM 2310</td></tr> <tr><td>186122</td><td>ZWM 2311</td></tr> </tbody> </table> | Art.-Nr. | Typ       | 228122 | SAY 32-6  | 228122-iK | SAY 32-6-iK | 238122 | SAY 32-6 | 229122    | SAY 32-6 | 230122  | SAY 32-6 | 226122 | SAY 40-6 | 227122      | SAY 40-6 | 231122      | SAY 40-6 |             |        | <b>Grundwerkzeughalter für Seitenschlitten<br/>INDEX MS25<br/>incl. schwenkbarem Nutenstein</b> |        |  |        | Art.-Nr.    | Typ | 185122 | ZWM 2310 | 186122      | ZWM 2311 | <table border="1"> <thead> <tr> <th>Art.-Nr.</th> <th>Typ</th> </tr> </thead> <tbody> <tr><td>161123</td><td>WTM 2050</td></tr> <tr><td>162123</td><td>WTM 2051</td></tr> <tr><td>162123-iK</td><td>WTM 2051-iK</td></tr> <tr><td>163123</td><td>WTM 2051-S</td></tr> <tr><td>164123</td><td>WTM 2052</td></tr> <tr><td>145125</td><td>WTM 3050</td></tr> <tr><td>146125</td><td>WTM 3051</td></tr> <tr><td>147125</td><td>WTM 3051-S</td></tr> <tr><td>148125</td><td>WTM 3052</td></tr> <tr><td>149125</td><td>WTM 3052-S</td></tr> <tr><td>150125</td><td>WTM 3053</td></tr> <tr><td>165123</td><td>WTM 2060</td></tr> <tr><td>166123</td><td>WTM 2061</td></tr> <tr><td>167123</td><td>WTM 2061-S</td></tr> <tr><td>168123</td><td>WTM 2062</td></tr> <tr><td>151125</td><td>WTM 3060</td></tr> <tr><td>152125</td><td>WTM 3061</td></tr> <tr><td>153125</td><td>WTM 3061-S</td></tr> <tr><td>154125</td><td>WTM 3062</td></tr> <tr><td>155125</td><td>WTM 3062-S</td></tr> <tr><td>156125</td><td>WTM 3063</td></tr> <tr><td colspan="2"> </td></tr> <tr><td>155123</td><td>WTM 2071</td></tr> <tr><td>156123</td><td>WTM 2072</td></tr> </tbody> </table> | Art.-Nr. | Typ         | 161123 | WTM 2050    | 162123 | WTM 2051    | 162123-iK | WTM 2051-iK | 163123 | WTM 2051-S    | 164123 | WTM 2052    | 145125 | WTM 3050 | 146125 | WTM 3051 | 147125 | WTM 3051-S | 148125 | WTM 3052 | 149125 | WTM 3052-S | 150125 | WTM 3053 | 165123 | WTM 2060 | 166123 | WTM 2061 | 167123 | WTM 2061-S | 168123 | WTM 2062 | 151125 | WTM 3060 | 152125 | WTM 3061 | 153125 | WTM 3061-S | 154125 | WTM 3062 | 155125 | WTM 3062-S | 156125 | WTM 3063 |  |  | 155123 | WTM 2071 | 156123 | WTM 2072 |
| Art.-Nr.  | Typ   |   |        |          |         |          |         |          |         |          |         |          |         |            |         |          |         |          |         |          |         |          |         |          |         |        |         |              |         |              |         |              |         |              |         |               |         |               |         |               |         |               |         |               |        |               |           |               |           |               |   |          |           |        |           |           |             |        |          |           |          |   |          |        |          |             |          |             |          |             |        |   |        |   |        |             |     |        |          |             |          |   |          |             |        |             |        |             |           |             |        |               |        |             |        |          |        |          |        |            |        |          |        |            |        |          |        |          |        |          |        |            |        |          |        |          |        |          |        |            |        |          |        |            |        |          |  |  |        |          |        |          |
| 164122  | ZWM 2130  |   |        |          |         |          |         |          |         |          |         |          |         |            |         |          |         |          |         |          |         |          |         |          |         |        |         |              |         |              |         |              |         |              |         |               |         |               |         |               |         |               |         |               |        |               |           |               |           |               |   |          |           |        |           |           |             |        |          |           |          |   |          |        |          |             |          |             |          |             |        |   |        |   |        |             |     |        |          |             |          |   |          |             |        |             |        |             |           |             |        |               |        |             |        |          |        |          |        |            |        |          |        |            |        |          |        |          |        |          |        |            |        |          |        |          |        |          |        |            |        |          |        |            |        |          |  |  |        |          |        |          |
| 165122  | ZWM 2131  |   |        |          |         |          |         |          |         |          |         |          |         |            |         |          |         |          |         |          |         |          |         |          |         |        |         |              |         |              |         |              |         |              |         |               |         |               |         |               |         |               |         |               |        |               |           |               |           |               |   |          |           |        |           |           |             |        |          |           |          |   |          |        |          |             |          |             |          |             |        |   |        |   |        |             |     |        |          |             |          |   |          |             |        |             |        |             |           |             |        |               |        |             |        |          |        |          |        |            |        |          |        |            |        |          |        |          |        |          |        |            |        |          |        |          |        |          |        |            |        |          |        |            |        |          |  |  |        |          |        |          |
| 146124  | ZWM 3130  |   |        |          |         |          |         |          |         |          |         |          |         |            |         |          |         |          |         |          |         |          |         |          |         |        |         |              |         |              |         |              |         |              |         |               |         |               |         |               |         |               |         |               |        |               |           |               |           |               |   |          |           |        |           |           |             |        |          |           |          |   |          |        |          |             |          |             |          |             |        |   |        |   |        |             |     |        |          |             |          |   |          |             |        |             |        |             |           |             |        |               |        |             |        |          |        |          |        |            |        |          |        |            |        |          |        |          |        |          |        |            |        |          |        |          |        |          |        |            |        |          |        |            |        |          |  |  |        |          |        |          |
| 147124  | ZWM 3131  |   |        |          |         |          |         |          |         |          |         |          |         |            |         |          |         |          |         |          |         |          |         |          |         |        |         |              |         |              |         |              |         |              |         |               |         |               |         |               |         |               |         |               |        |               |           |               |           |               |   |          |           |        |           |           |             |        |          |           |          |   |          |        |          |             |          |             |          |             |        |   |        |   |        |             |     |        |          |             |          |   |          |             |        |             |        |             |           |             |        |               |        |             |        |          |        |          |        |            |        |          |        |            |        |          |        |          |        |          |        |            |        |          |        |          |        |          |        |            |        |          |        |            |        |          |  |  |        |          |        |          |
| 148124  | ZWM 3132  |   |        |          |         |          |         |          |         |          |         |          |         |            |         |          |         |          |         |          |         |          |         |          |         |        |         |              |         |              |         |              |         |              |         |               |         |               |         |               |         |               |         |               |        |               |           |               |           |               |   |          |           |        |           |           |             |        |          |           |          |   |          |        |          |             |          |             |          |             |        |   |        |   |        |             |     |        |          |             |          |   |          |             |        |             |        |             |           |             |        |               |        |             |        |          |        |          |        |            |        |          |        |            |        |          |        |          |        |          |        |            |        |          |        |          |        |          |        |            |        |          |        |            |        |          |  |  |        |          |        |          |
| 157124  | ZWM 3130-S  |   |        |          |         |          |         |          |         |          |         |          |         |            |         |          |         |          |         |          |         |          |         |          |         |        |         |              |         |              |         |              |         |              |         |               |         |               |         |               |         |               |         |               |        |               |           |               |           |               |   |          |           |        |           |           |             |        |          |           |          |   |          |        |          |             |          |             |          |             |        |   |        |   |        |             |     |        |          |             |          |   |          |             |        |             |        |             |           |             |        |               |        |             |        |          |        |          |        |            |        |          |        |            |        |          |        |          |        |          |        |            |        |          |        |          |        |          |        |            |        |          |        |            |        |          |  |  |        |          |        |          |
| 166122  | ZWM 2140  |   |        |          |         |          |         |          |         |          |         |          |         |            |         |          |         |          |         |          |         |          |         |          |         |        |         |              |         |              |         |              |         |              |         |               |         |               |         |               |         |               |         |               |        |               |           |               |           |               |   |          |           |        |           |           |             |        |          |           |          |   |          |        |          |             |          |             |          |             |        |   |        |   |        |             |     |        |          |             |          |   |          |             |        |             |        |             |           |             |        |               |        |             |        |          |        |          |        |            |        |          |        |            |        |          |        |          |        |          |        |            |        |          |        |          |        |          |        |            |        |          |        |            |        |          |  |  |        |          |        |          |
| 167122  | ZWM 2141  |   |        |          |         |          |         |          |         |          |         |          |         |            |         |          |         |          |         |          |         |          |         |          |         |        |         |              |         |              |         |              |         |              |         |               |         |               |         |               |         |               |         |               |        |               |           |               |           |               |   |          |           |        |           |           |             |        |          |           |          |   |          |        |          |             |          |             |          |             |        |   |        |   |        |             |     |        |          |             |          |   |          |             |        |             |        |             |           |             |        |               |        |             |        |          |        |          |        |            |        |          |        |            |        |          |        |          |        |          |        |            |        |          |        |          |        |          |        |            |        |          |        |            |        |          |  |  |        |          |        |          |
| 161124  | ZWM 3140  |   |        |          |         |          |         |          |         |          |         |          |         |            |         |          |         |          |         |          |         |          |         |          |         |        |         |              |         |              |         |              |         |              |         |               |         |               |         |               |         |               |         |               |        |               |           |               |           |               |   |          |           |        |           |           |             |        |          |           |          |   |          |        |          |             |          |             |          |             |        |   |        |   |        |             |     |        |          |             |          |   |          |             |        |             |        |             |           |             |        |               |        |             |        |          |        |          |        |            |        |          |        |            |        |          |        |          |        |          |        |            |        |          |        |          |        |          |        |            |        |          |        |            |        |          |  |  |        |          |        |          |
| 149124  | ZWM 3141  |   |        |          |         |          |         |          |         |          |         |          |         |            |         |          |         |          |         |          |         |          |         |          |         |        |         |              |         |              |         |              |         |              |         |               |         |               |         |               |         |               |         |               |        |               |           |               |           |               |   |          |           |        |           |           |             |        |          |           |          |   |          |        |          |             |          |             |          |             |        |   |        |   |        |             |     |        |          |             |          |   |          |             |        |             |        |             |           |             |        |               |        |             |        |          |        |          |        |            |        |          |        |            |        |          |        |          |        |          |        |            |        |          |        |          |        |          |        |            |        |          |        |            |        |          |  |  |        |          |        |          |
| 150124  | ZWM 3142  |   |        |          |         |          |         |          |         |          |         |          |         |            |         |          |         |          |         |          |         |          |         |          |         |        |         |              |         |              |         |              |         |              |         |               |         |               |         |               |         |               |         |               |        |               |           |               |           |               |   |          |           |        |           |           |             |        |          |           |          |   |          |        |          |             |          |             |          |             |        |   |        |   |        |             |     |        |          |             |          |   |          |             |        |             |        |             |           |             |        |               |        |             |        |          |        |          |        |            |        |          |        |            |        |          |        |          |        |          |        |            |        |          |        |          |        |          |        |            |        |          |        |            |        |          |  |  |        |          |        |          |
|   |   |   |        |          |         |          |         |          |         |          |         |          |         |            |         |          |         |          |         |          |         |          |         |          |         |        |         |              |         |              |         |              |         |              |         |               |         |               |         |               |         |               |         |               |        |               |           |               |           |               |   |          |           |        |           |           |             |        |          |           |          |   |          |        |          |             |          |             |          |             |        |   |        |   |        |             |     |        |          |             |          |   |          |             |        |             |        |             |           |             |        |               |        |             |        |          |        |          |        |            |        |          |        |            |        |          |        |          |        |          |        |            |        |          |        |          |        |          |        |            |        |          |        |            |        |          |  |  |        |          |        |          |
| 110130  | N 2130-15,87  |   |        |          |         |          |         |          |         |          |         |          |         |            |         |          |         |          |         |          |         |          |         |          |         |        |         |              |         |              |         |              |         |              |         |               |         |               |         |               |         |               |         |               |        |               |           |               |           |               |   |          |           |        |           |           |             |        |          |           |          |   |          |        |          |             |          |             |          |             |        |   |        |   |        |             |     |        |          |             |          |   |          |             |        |             |        |             |           |             |        |               |        |             |        |          |        |          |        |            |        |          |        |            |        |          |        |          |        |          |        |            |        |          |        |          |        |          |        |            |        |          |        |            |        |          |  |  |        |          |        |          |
| 111130  | N 2131-19,05  |   |        |          |         |          |         |          |         |          |         |          |         |            |         |          |         |          |         |          |         |          |         |          |         |        |         |              |         |              |         |              |         |              |         |               |         |               |         |               |         |               |         |               |        |               |           |               |           |               |   |          |           |        |           |           |             |        |          |           |          |   |          |        |          |             |          |             |          |             |        |   |        |   |        |             |     |        |          |             |          |   |          |             |        |             |        |             |           |             |        |               |        |             |        |          |        |          |        |            |        |          |        |            |        |          |        |          |        |          |        |            |        |          |        |          |        |          |        |            |        |          |        |            |        |          |  |  |        |          |        |          |
| 112130  | N 3130-19,05  |   |        |          |         |          |         |          |         |          |         |          |         |            |         |          |         |          |         |          |         |          |         |          |         |        |         |              |         |              |         |              |         |              |         |               |         |               |         |               |         |               |         |               |        |               |           |               |           |               |   |          |           |        |           |           |             |        |          |           |          |   |          |        |          |             |          |             |          |             |        |   |        |   |        |             |     |        |          |             |          |   |          |             |        |             |        |             |           |             |        |               |        |             |        |          |        |          |        |            |        |          |        |            |        |          |        |          |        |          |        |            |        |          |        |          |        |          |        |            |        |          |        |            |        |          |  |  |        |          |        |          |
| 114130  | N 3132-22,22  |   |        |          |         |          |         |          |         |          |         |          |         |            |         |          |         |          |         |          |         |          |         |          |         |        |         |              |         |              |         |              |         |              |         |               |         |               |         |               |         |               |         |               |        |               |           |               |           |               |   |          |           |        |           |           |             |        |          |           |          |   |          |        |          |             |          |             |          |             |        |   |        |   |        |             |     |        |          |             |          |   |          |             |        |             |        |             |           |             |        |               |        |             |        |          |        |          |        |            |        |          |        |            |        |          |        |          |        |          |        |            |        |          |        |          |        |          |        |            |        |          |        |            |        |          |  |  |        |          |        |          |
| 190130  | NS 2130-15,87   |   |        |          |         |          |         |          |         |          |         |          |         |            |         |          |         |          |         |          |         |          |         |          |         |        |         |              |         |              |         |              |         |              |         |               |         |               |         |               |         |               |         |               |        |               |           |               |           |               |   |          |           |        |           |           |             |        |          |           |          |   |          |        |          |             |          |             |          |             |        |   |        |   |        |             |     |        |          |             |          |   |          |             |        |             |        |             |           |             |        |               |        |             |        |          |        |          |        |            |        |          |        |            |        |          |        |          |        |          |        |            |        |          |        |          |        |          |        |            |        |          |        |            |        |          |  |  |        |          |        |          |
| 191130  | NS 2131-19,05   |   |        |          |         |          |         |          |         |          |         |          |         |            |         |          |         |          |         |          |         |          |         |          |         |        |         |              |         |              |         |              |         |              |         |               |         |               |         |               |         |               |         |               |        |               |           |               |           |               |   |          |           |        |           |           |             |        |          |           |          |   |          |        |          |             |          |             |          |             |        |   |        |   |        |             |     |        |          |             |          |   |          |             |        |             |        |             |           |             |        |               |        |             |        |          |        |          |        |            |        |          |        |            |        |          |        |          |        |          |        |            |        |          |        |          |        |          |        |            |        |          |        |            |        |          |  |  |        |          |        |          |
| 192130  | NS 3130-19,05   |   |        |          |         |          |         |          |         |          |         |          |         |            |         |          |         |          |         |          |         |          |         |          |         |        |         |              |         |              |         |              |         |              |         |               |         |               |         |               |         |               |         |               |        |               |           |               |           |               |   |          |           |        |           |           |             |        |          |           |          |   |          |        |          |             |          |             |          |             |        |   |        |   |        |             |     |        |          |             |          |   |          |             |        |             |        |             |           |             |        |               |        |             |        |          |        |          |        |            |        |          |        |            |        |          |        |          |        |          |        |            |        |          |        |          |        |          |        |            |        |          |        |            |        |          |  |  |        |          |        |          |
| 194130  | NS 3132-22,22   |   |        |          |         |          |         |          |         |          |         |          |         |            |         |          |         |          |         |          |         |          |         |          |         |        |         |              |         |              |         |              |         |              |         |               |         |               |         |               |         |               |         |               |        |               |           |               |           |               |   |          |           |        |           |           |             |        |          |           |          |   |          |        |          |             |          |             |          |             |        |   |        |   |        |             |     |        |          |             |          |   |          |             |        |             |        |             |           |             |        |               |        |             |        |          |        |          |        |            |        |          |        |            |        |          |        |          |        |          |        |            |        |          |        |          |        |          |        |            |        |          |        |            |        |          |  |  |        |          |        |          |
| 195130  | NS 2140-15,87   |   |        |          |         |          |         |          |         |          |         |          |         |            |         |          |         |          |         |          |         |          |         |          |         |        |         |              |         |              |         |              |         |              |         |               |         |               |         |               |         |               |         |               |        |               |           |               |           |               |   |          |           |        |           |           |             |        |          |           |          |   |          |        |          |             |          |             |          |             |        |   |        |   |        |             |     |        |          |             |          |   |          |             |        |             |        |             |           |             |        |               |        |             |        |          |        |          |        |            |        |          |        |            |        |          |        |          |        |          |        |            |        |          |        |          |        |          |        |            |        |          |        |            |        |          |  |  |        |          |        |          |
| 196130  | NS 2141-19,05   |   |        |          |         |          |         |          |         |          |         |          |         |            |         |          |         |          |         |          |         |          |         |          |         |        |         |              |         |              |         |              |         |              |         |               |         |               |         |               |         |               |         |               |        |               |           |               |           |               |   |          |           |        |           |           |             |        |          |           |          |   |          |        |          |             |          |             |          |             |        |   |        |   |        |             |     |        |          |             |          |   |          |             |        |             |        |             |           |             |        |               |        |             |        |          |        |          |        |            |        |          |        |            |        |          |        |          |        |          |        |            |        |          |        |          |        |          |        |            |        |          |        |            |        |          |  |  |        |          |        |          |
| 197130  | NS 3141-19,05   |   |        |          |         |          |         |          |         |          |         |          |         |            |         |          |         |          |         |          |         |          |         |          |         |        |         |              |         |              |         |              |         |              |         |               |         |               |         |               |         |               |         |               |        |               |           |               |           |               |   |          |           |        |           |           |             |        |          |           |          |   |          |        |          |             |          |             |          |             |        |   |        |   |        |             |     |        |          |             |          |   |          |             |        |             |        |             |           |             |        |               |        |             |        |          |        |          |        |            |        |          |        |            |        |          |        |          |        |          |        |            |        |          |        |          |        |          |        |            |        |          |        |            |        |          |  |  |        |          |        |          |
| 198130  | NS 3142-22,22   |   |        |          |         |          |         |          |         |          |         |          |         |            |         |          |         |          |         |          |         |          |         |          |         |        |         |              |         |              |         |              |         |              |         |               |         |               |         |               |         |               |         |               |        |               |           |               |           |               |   |          |           |        |           |           |             |        |          |           |          |   |          |        |          |             |          |             |          |             |        |   |        |   |        |             |     |        |          |             |          |   |          |             |        |             |        |             |           |             |        |               |        |             |        |          |        |          |        |            |        |          |        |            |        |          |        |          |        |          |        |            |        |          |        |          |        |          |        |            |        |          |        |            |        |          |  |  |        |          |        |          |
| Art.-Nr.  | Typ   |   |        |          |         |          |         |          |         |          |         |          |         |            |         |          |         |          |         |          |         |          |         |          |         |        |         |              |         |              |         |              |         |              |         |               |         |               |         |               |         |               |         |               |        |               |           |               |           |               |   |          |           |        |           |           |             |        |          |           |          |   |          |        |          |             |          |             |          |             |        |   |        |   |        |             |     |        |          |             |          |   |          |             |        |             |        |             |           |             |        |               |        |             |        |          |        |          |        |            |        |          |        |            |        |          |        |          |        |          |        |            |        |          |        |          |        |          |        |            |        |          |        |            |        |          |  |  |        |          |        |          |
| 228122  | SAY 32-6  |   |        |          |         |          |         |          |         |          |         |          |         |            |         |          |         |          |         |          |         |          |         |          |         |        |         |              |         |              |         |              |         |              |         |               |         |               |         |               |         |               |         |               |        |               |           |               |           |               |   |          |           |        |           |           |             |        |          |           |          |   |          |        |          |             |          |             |          |             |        |   |        |   |        |             |     |        |          |             |          |   |          |             |        |             |        |             |           |             |        |               |        |             |        |          |        |          |        |            |        |          |        |            |        |          |        |          |        |          |        |            |        |          |        |          |        |          |        |            |        |          |        |            |        |          |  |  |        |          |        |          |
| 228122-iK   | SAY 32-6-iK   |   |        |          |         |          |         |          |         |          |         |          |         |            |         |          |         |          |         |          |         |          |         |          |         |        |         |              |         |              |         |              |         |              |         |               |         |               |         |               |         |               |         |               |        |               |           |               |           |               |   |          |           |        |           |           |             |        |          |           |          |   |          |        |          |             |          |             |          |             |        |   |        |   |        |             |     |        |          |             |          |   |          |             |        |             |        |             |           |             |        |               |        |             |        |          |        |          |        |            |        |          |        |            |        |          |        |          |        |          |        |            |        |          |        |          |        |          |        |            |        |          |        |            |        |          |  |  |        |          |        |          |
| 238122  | SAY 32-6  |   |        |          |         |          |         |          |         |          |         |          |         |            |         |          |         |          |         |          |         |          |         |          |         |        |         |              |         |              |         |              |         |              |         |               |         |               |         |               |         |               |         |               |        |               |           |               |           |               |   |          |           |        |           |           |             |        |          |           |          |   |          |        |          |             |          |             |          |             |        |   |        |   |        |             |     |        |          |             |          |   |          |             |        |             |        |             |           |             |        |               |        |             |        |          |        |          |        |            |        |          |        |            |        |          |        |          |        |          |        |            |        |          |        |          |        |          |        |            |        |          |        |            |        |          |  |  |        |          |        |          |
| 229122  | SAY 32-6  |   |        |          |         |          |         |          |         |          |         |          |         |            |         |          |         |          |         |          |         |          |         |          |         |        |         |              |         |              |         |              |         |              |         |               |         |               |         |               |         |               |         |               |        |               |           |               |           |               |   |          |           |        |           |           |             |        |          |           |          |   |          |        |          |             |          |             |          |             |        |   |        |   |        |             |     |        |          |             |          |   |          |             |        |             |        |             |           |             |        |               |        |             |        |          |        |          |        |            |        |          |        |            |        |          |        |          |        |          |        |            |        |          |        |          |        |          |        |            |        |          |        |            |        |          |  |  |        |          |        |          |
| 230122  | SAY 32-6  |   |        |          |         |          |         |          |         |          |         |          |         |            |         |          |         |          |         |          |         |          |         |          |         |        |         |              |         |              |         |              |         |              |         |               |         |               |         |               |         |               |         |               |        |               |           |               |           |               |   |          |           |        |           |           |             |        |          |           |          |   |          |        |          |             |          |             |          |             |        |   |        |   |        |             |     |        |          |             |          |   |          |             |        |             |        |             |           |             |        |               |        |             |        |          |        |          |        |            |        |          |        |            |        |          |        |          |        |          |        |            |        |          |        |          |        |          |        |            |        |          |        |            |        |          |  |  |        |          |        |          |
| 226122  | SAY 40-6  |   |        |          |         |          |         |          |         |          |         |          |         |            |         |          |         |          |         |          |         |          |         |          |         |        |         |              |         |              |         |              |         |              |         |               |         |               |         |               |         |               |         |               |        |               |           |               |           |               |   |          |           |        |           |           |             |        |          |           |          |   |          |        |          |             |          |             |          |             |        |   |        |   |        |             |     |        |          |             |          |   |          |             |        |             |        |             |           |             |        |               |        |             |        |          |        |          |        |            |        |          |        |            |        |          |        |          |        |          |        |            |        |          |        |          |        |          |        |            |        |          |        |            |        |          |  |  |        |          |        |          |
| 227122  | SAY 40-6  |   |        |          |         |          |         |          |         |          |         |          |         |            |         |          |         |          |         |          |         |          |         |          |         |        |         |              |         |              |         |              |         |              |         |               |         |               |         |               |         |               |         |               |        |               |           |               |           |               |   |          |           |        |           |           |             |        |          |           |          |   |          |        |          |             |          |             |          |             |        |   |        |   |        |             |     |        |          |             |          |   |          |             |        |             |        |             |           |             |        |               |        |             |        |          |        |          |        |            |        |          |        |            |        |          |        |          |        |          |        |            |        |          |        |          |        |          |        |            |        |          |        |            |        |          |  |  |        |          |        |          |
| 231122  | SAY 40-6  |   |        |          |         |          |         |          |         |          |         |          |         |            |         |          |         |          |         |          |         |          |         |          |         |        |         |              |         |              |         |              |         |              |         |               |         |               |         |               |         |               |         |               |        |               |           |               |           |               |   |          |           |        |           |           |             |        |          |           |          |   |          |        |          |             |          |             |          |             |        |   |        |   |        |             |     |        |          |             |          |   |          |             |        |             |        |             |           |             |        |               |        |             |        |          |        |          |        |            |        |          |        |            |        |          |        |          |        |          |        |            |        |          |        |          |        |          |        |            |        |          |        |            |        |          |  |  |        |          |        |          |
|   |   |   |        |          |         |          |         |          |         |          |         |          |         |            |         |          |         |          |         |          |         |          |         |          |         |        |         |              |         |              |         |              |         |              |         |               |         |               |         |               |         |               |         |               |        |               |           |               |           |               |   |          |           |        |           |           |             |        |          |           |          |   |          |        |          |             |          |             |          |             |        |   |        |   |        |             |     |        |          |             |          |   |          |             |        |             |        |             |           |             |        |               |        |             |        |          |        |          |        |            |        |          |        |            |        |          |        |          |        |          |        |            |        |          |        |          |        |          |        |            |        |          |        |            |        |          |  |  |        |          |        |          |
| <b>Grundwerkzeughalter für Seitenschlitten<br/>INDEX MS25<br/>incl. schwenkbarem Nutenstein</b>   |   |   |        |          |         |          |         |          |         |          |         |          |         |            |         |          |         |          |         |          |         |          |         |          |         |        |         |              |         |              |         |              |         |              |         |               |         |               |         |               |         |               |         |               |        |               |           |               |           |               |   |          |           |        |           |           |             |        |          |           |          |   |          |        |          |             |          |             |          |             |        |   |        |   |        |             |     |        |          |             |          |   |          |             |        |             |        |             |           |             |        |               |        |             |        |          |        |          |        |            |        |          |        |            |        |          |        |          |        |          |        |            |        |          |        |          |        |          |        |            |        |          |        |            |        |          |  |  |        |          |        |          |
|    |   |   |        |          |         |          |         |          |         |          |         |          |         |            |         |          |         |          |         |          |         |          |         |          |         |        |         |              |         |              |         |              |         |              |         |               |         |               |         |               |         |               |         |               |        |               |           |               |           |               |   |          |           |        |           |           |             |        |          |           |          |   |          |        |          |             |          |             |          |             |        |   |        |   |        |             |     |        |          |             |          |   |          |             |        |             |        |             |           |             |        |               |        |             |        |          |        |          |        |            |        |          |        |            |        |          |        |          |        |          |        |            |        |          |        |          |        |          |        |            |        |          |        |            |        |          |  |  |        |          |        |          |
| Art.-Nr.  | Typ   |   |        |          |         |          |         |          |         |          |         |          |         |            |         |          |         |          |         |          |         |          |         |          |         |        |         |              |         |              |         |              |         |              |         |               |         |               |         |               |         |               |         |               |        |               |           |               |           |               |   |          |           |        |           |           |             |        |          |           |          |   |          |        |          |             |          |             |          |             |        |   |        |   |        |             |     |        |          |             |          |   |          |             |        |             |        |             |           |             |        |               |        |             |        |          |        |          |        |            |        |          |        |            |        |          |        |          |        |          |        |            |        |          |        |          |        |          |        |            |        |          |        |            |        |          |  |  |        |          |        |          |
| 185122  | ZWM 2310  |   |        |          |         |          |         |          |         |          |         |          |         |            |         |          |         |          |         |          |         |          |         |          |         |        |         |              |         |              |         |              |         |              |         |               |         |               |         |               |         |               |         |               |        |               |           |               |           |               |   |          |           |        |           |           |             |        |          |           |          |   |          |        |          |             |          |             |          |             |        |   |        |   |        |             |     |        |          |             |          |   |          |             |        |             |        |             |           |             |        |               |        |             |        |          |        |          |        |            |        |          |        |            |        |          |        |          |        |          |        |            |        |          |        |          |        |          |        |            |        |          |        |            |        |          |  |  |        |          |        |          |
| 186122  | ZWM 2311  |   |        |          |         |          |         |          |         |          |         |          |         |            |         |          |         |          |         |          |         |          |         |          |         |        |         |              |         |              |         |              |         |              |         |               |         |               |         |               |         |               |         |               |        |               |           |               |           |               |   |          |           |        |           |           |             |        |          |           |          |   |          |        |          |             |          |             |          |             |        |   |        |   |        |             |     |        |          |             |          |   |          |             |        |             |        |             |           |             |        |               |        |             |        |          |        |          |        |            |        |          |        |            |        |          |        |          |        |          |        |            |        |          |        |          |        |          |        |            |        |          |        |            |        |          |  |  |        |          |        |          |
| Art.-Nr.  | Typ   |   |        |          |         |          |         |          |         |          |         |          |         |            |         |          |         |          |         |          |         |          |         |          |         |        |         |              |         |              |         |              |         |              |         |               |         |               |         |               |         |               |         |               |        |               |           |               |           |               |   |          |           |        |           |           |             |        |          |           |          |   |          |        |          |             |          |             |          |             |        |   |        |   |        |             |     |        |          |             |          |   |          |             |        |             |        |             |           |             |        |               |        |             |        |          |        |          |        |            |        |          |        |            |        |          |        |          |        |          |        |            |        |          |        |          |        |          |        |            |        |          |        |            |        |          |  |  |        |          |        |          |
| 161123  | WTM 2050  |   |        |          |         |          |         |          |         |          |         |          |         |            |         |          |         |          |         |          |         |          |         |          |         |        |         |              |         |              |         |              |         |              |         |               |         |               |         |               |         |               |         |               |        |               |           |               |           |               |   |          |           |        |           |           |             |        |          |           |          |   |          |        |          |             |          |             |          |             |        |   |        |   |        |             |     |        |          |             |          |   |          |             |        |             |        |             |           |             |        |               |        |             |        |          |        |          |        |            |        |          |        |            |        |          |        |          |        |          |        |            |        |          |        |          |        |          |        |            |        |          |        |            |        |          |  |  |        |          |        |          |
| 162123  | WTM 2051  |   |        |          |         |          |         |          |         |          |         |          |         |            |         |          |         |          |         |          |         |          |         |          |         |        |         |              |         |              |         |              |         |              |         |               |         |               |         |               |         |               |         |               |        |               |           |               |           |               |   |          |           |        |           |           |             |        |          |           |          |   |          |        |          |             |          |             |          |             |        |   |        |   |        |             |     |        |          |             |          |   |          |             |        |             |        |             |           |             |        |               |        |             |        |          |        |          |        |            |        |          |        |            |        |          |        |          |        |          |        |            |        |          |        |          |        |          |        |            |        |          |        |            |        |          |  |  |        |          |        |          |
| 162123-iK   | WTM 2051-iK   |   |        |          |         |          |         |          |         |          |         |          |         |            |         |          |         |          |         |          |         |          |         |          |         |        |         |              |         |              |         |              |         |              |         |               |         |               |         |               |         |               |         |               |        |               |           |               |           |               |   |          |           |        |           |           |             |        |          |           |          |   |          |        |          |             |          |             |          |             |        |   |        |   |        |             |     |        |          |             |          |   |          |             |        |             |        |             |           |             |        |               |        |             |        |          |        |          |        |            |        |          |        |            |        |          |        |          |        |          |        |            |        |          |        |          |        |          |        |            |        |          |        |            |        |          |  |  |        |          |        |          |
| 163123  | WTM 2051-S  |   |        |          |         |          |         |          |         |          |         |          |         |            |         |          |         |          |         |          |         |          |         |          |         |        |         |              |         |              |         |              |         |              |         |               |         |               |         |               |         |               |         |               |        |               |           |               |           |               |   |          |           |        |           |           |             |        |          |           |          |   |          |        |          |             |          |             |          |             |        |   |        |   |        |             |     |        |          |             |          |   |          |             |        |             |        |             |           |             |        |               |        |             |        |          |        |          |        |            |        |          |        |            |        |          |        |          |        |          |        |            |        |          |        |          |        |          |        |            |        |          |        |            |        |          |  |  |        |          |        |          |
| 164123  | WTM 2052  |   |        |          |         |          |         |          |         |          |         |          |         |            |         |          |         |          |         |          |         |          |         |          |         |        |         |              |         |              |         |              |         |              |         |               |         |               |         |               |         |               |         |               |        |               |           |               |           |               |   |          |           |        |           |           |             |        |          |           |          |   |          |        |          |             |          |             |          |             |        |   |        |   |        |             |     |        |          |             |          |   |          |             |        |             |        |             |           |             |        |               |        |             |        |          |        |          |        |            |        |          |        |            |        |          |        |          |        |          |        |            |        |          |        |          |        |          |        |            |        |          |        |            |        |          |  |  |        |          |        |          |
| 145125  | WTM 3050  |   |        |          |         |          |         |          |         |          |         |          |         |            |         |          |         |          |         |          |         |          |         |          |         |        |         |              |         |              |         |              |         |              |         |               |         |               |         |               |         |               |         |               |        |               |           |               |           |               |   |          |           |        |           |           |             |        |          |           |          |   |          |        |          |             |          |             |          |             |        |   |        |   |        |             |     |        |          |             |          |   |          |             |        |             |        |             |           |             |        |               |        |             |        |          |        |          |        |            |        |          |        |            |        |          |        |          |        |          |        |            |        |          |        |          |        |          |        |            |        |          |        |            |        |          |  |  |        |          |        |          |
| 146125  | WTM 3051  |   |        |          |         |          |         |          |         |          |         |          |         |            |         |          |         |          |         |          |         |          |         |          |         |        |         |              |         |              |         |              |         |              |         |               |         |               |         |               |         |               |         |               |        |               |           |               |           |               |   |          |           |        |           |           |             |        |          |           |          |   |          |        |          |             |          |             |          |             |        |   |        |   |        |             |     |        |          |             |          |   |          |             |        |             |        |             |           |             |        |               |        |             |        |          |        |          |        |            |        |          |        |            |        |          |        |          |        |          |        |            |        |          |        |          |        |          |        |            |        |          |        |            |        |          |  |  |        |          |        |          |
| 147125  | WTM 3051-S  |   |        |          |         |          |         |          |         |          |         |          |         |            |         |          |         |          |         |          |         |          |         |          |         |        |         |              |         |              |         |              |         |              |         |               |         |               |         |               |         |               |         |               |        |               |           |               |           |               |   |          |           |        |           |           |             |        |          |           |          |   |          |        |          |             |          |             |          |             |        |   |        |   |        |             |     |        |          |             |          |   |          |             |        |             |        |             |           |             |        |               |        |             |        |          |        |          |        |            |        |          |        |            |        |          |        |          |        |          |        |            |        |          |        |          |        |          |        |            |        |          |        |            |        |          |  |  |        |          |        |          |
| 148125  | WTM 3052  |   |        |          |         |          |         |          |         |          |         |          |         |            |         |          |         |          |         |          |         |          |         |          |         |        |         |              |         |              |         |              |         |              |         |               |         |               |         |               |         |               |         |               |        |               |           |               |           |               |   |          |           |        |           |           |             |        |          |           |          |   |          |        |          |             |          |             |          |             |        |   |        |   |        |             |     |        |          |             |          |   |          |             |        |             |        |             |           |             |        |               |        |             |        |          |        |          |        |            |        |          |        |            |        |          |        |          |        |          |        |            |        |          |        |          |        |          |        |            |        |          |        |            |        |          |  |  |        |          |        |          |
| 149125  | WTM 3052-S  |   |        |          |         |          |         |          |         |          |         |          |         |            |         |          |         |          |         |          |         |          |         |          |         |        |         |              |         |              |         |              |         |              |         |               |         |               |         |               |         |               |         |               |        |               |           |               |           |               |   |          |           |        |           |           |             |        |          |           |          |   |          |        |          |             |          |             |          |             |        |   |        |   |        |             |     |        |          |             |          |   |          |             |        |             |        |             |           |             |        |               |        |             |        |          |        |          |        |            |        |          |        |            |        |          |        |          |        |          |        |            |        |          |        |          |        |          |        |            |        |          |        |            |        |          |  |  |        |          |        |          |
| 150125  | WTM 3053  |   |        |          |         |          |         |          |         |          |         |          |         |            |         |          |         |          |         |          |         |          |         |          |         |        |         |              |         |              |         |              |         |              |         |               |         |               |         |               |         |               |         |               |        |               |           |               |           |               |   |          |           |        |           |           |             |        |          |           |          |   |          |        |          |             |          |             |          |             |        |   |        |   |        |             |     |        |          |             |          |   |          |             |        |             |        |             |           |             |        |               |        |             |        |          |        |          |        |            |        |          |        |            |        |          |        |          |        |          |        |            |        |          |        |          |        |          |        |            |        |          |        |            |        |          |  |  |        |          |        |          |
| 165123  | WTM 2060  |   |        |          |         |          |         |          |         |          |         |          |         |            |         |          |         |          |         |          |         |          |         |          |         |        |         |              |         |              |         |              |         |              |         |               |         |               |         |               |         |               |         |               |        |               |           |               |           |               |   |          |           |        |           |           |             |        |          |           |          |   |          |        |          |             |          |             |          |             |        |   |        |   |        |             |     |        |          |             |          |   |          |             |        |             |        |             |           |             |        |               |        |             |        |          |        |          |        |            |        |          |        |            |        |          |        |          |        |          |        |            |        |          |        |          |        |          |        |            |        |          |        |            |        |          |  |  |        |          |        |          |
| 166123  | WTM 2061  |   |        |          |         |          |         |          |         |          |         |          |         |            |         |          |         |          |         |          |         |          |         |          |         |        |         |              |         |              |         |              |         |              |         |               |         |               |         |               |         |               |         |               |        |               |           |               |           |               |   |          |           |        |           |           |             |        |          |           |          |   |          |        |          |             |          |             |          |             |        |   |        |   |        |             |     |        |          |             |          |   |          |             |        |             |        |             |           |             |        |               |        |             |        |          |        |          |        |            |        |          |        |            |        |          |        |          |        |          |        |            |        |          |        |          |        |          |        |            |        |          |        |            |        |          |  |  |        |          |        |          |
| 167123  | WTM 2061-S  |   |        |          |         |          |         |          |         |          |         |          |         |            |         |          |         |          |         |          |         |          |         |          |         |        |         |              |         |              |         |              |         |              |         |               |         |               |         |               |         |               |         |               |        |               |           |               |           |               |   |          |           |        |           |           |             |        |          |           |          |   |          |        |          |             |          |             |          |             |        |   |        |   |        |             |     |        |          |             |          |   |          |             |        |             |        |             |           |             |        |               |        |             |        |          |        |          |        |            |        |          |        |            |        |          |        |          |        |          |        |            |        |          |        |          |        |          |        |            |        |          |        |            |        |          |  |  |        |          |        |          |
| 168123  | WTM 2062  |   |        |          |         |          |         |          |         |          |         |          |         |            |         |          |         |          |         |          |         |          |         |          |         |        |         |              |         |              |         |              |         |              |         |               |         |               |         |               |         |               |         |               |        |               |           |               |           |               |   |          |           |        |           |           |             |        |          |           |          |   |          |        |          |             |          |             |          |             |        |   |        |   |        |             |     |        |          |             |          |   |          |             |        |             |        |             |           |             |        |               |        |             |        |          |        |          |        |            |        |          |        |            |        |          |        |          |        |          |        |            |        |          |        |          |        |          |        |            |        |          |        |            |        |          |  |  |        |          |        |          |
| 151125  | WTM 3060  |   |        |          |         |          |         |          |         |          |         |          |         |            |         |          |         |          |         |          |         |          |         |          |         |        |         |              |         |              |         |              |         |              |         |               |         |               |         |               |         |               |         |               |        |               |           |               |           |               |   |          |           |        |           |           |             |        |          |           |          |   |          |        |          |             |          |             |          |             |        |   |        |   |        |             |     |        |          |             |          |   |          |             |        |             |        |             |           |             |        |               |        |             |        |          |        |          |        |            |        |          |        |            |        |          |        |          |        |          |        |            |        |          |        |          |        |          |        |            |        |          |        |            |        |          |  |  |        |          |        |          |
| 152125  | WTM 3061  |   |        |          |         |          |         |          |         |          |         |          |         |            |         |          |         |          |         |          |         |          |         |          |         |        |         |              |         |              |         |              |         |              |         |               |         |               |         |               |         |               |         |               |        |               |           |               |           |               |   |          |           |        |           |           |             |        |          |           |          |   |          |        |          |             |          |             |          |             |        |   |        |   |        |             |     |        |          |             |          |   |          |             |        |             |        |             |           |             |        |               |        |             |        |          |        |          |        |            |        |          |        |            |        |          |        |          |        |          |        |            |        |          |        |          |        |          |        |            |        |          |        |            |        |          |  |  |        |          |        |          |
| 153125  | WTM 3061-S  |   |        |          |         |          |         |          |         |          |         |          |         |            |         |          |         |          |         |          |         |          |         |          |         |        |         |              |         |              |         |              |         |              |         |               |         |               |         |               |         |               |         |               |        |               |           |               |           |               |   |          |           |        |           |           |             |        |          |           |          |   |          |        |          |             |          |             |          |             |        |   |        |   |        |             |     |        |          |             |          |   |          |             |        |             |        |             |           |             |        |               |        |             |        |          |        |          |        |            |        |          |        |            |        |          |        |          |        |          |        |            |        |          |        |          |        |          |        |            |        |          |        |            |        |          |  |  |        |          |        |          |
| 154125  | WTM 3062  |   |        |          |         |          |         |          |         |          |         |          |         |            |         |          |         |          |         |          |         |          |         |          |         |        |         |              |         |              |         |              |         |              |         |               |         |               |         |               |         |               |         |               |        |               |           |               |           |               |   |          |           |        |           |           |             |        |          |           |          |   |          |        |          |             |          |             |          |             |        |   |        |   |        |             |     |        |          |             |          |   |          |             |        |             |        |             |           |             |        |               |        |             |        |          |        |          |        |            |        |          |        |            |        |          |        |          |        |          |        |            |        |          |        |          |        |          |        |            |        |          |        |            |        |          |  |  |        |          |        |          |
| 155125  | WTM 3062-S  |   |        |          |         |          |         |          |         |          |         |          |         |            |         |          |         |          |         |          |         |          |         |          |         |        |         |              |         |              |         |              |         |              |         |               |         |               |         |               |         |               |         |               |        |               |           |               |           |               |   |          |           |        |           |           |             |        |          |           |          |   |          |        |          |             |          |             |          |             |        |   |        |   |        |             |     |        |          |             |          |   |          |             |        |             |        |             |           |             |        |               |        |             |        |          |        |          |        |            |        |          |        |            |        |          |        |          |        |          |        |            |        |          |        |          |        |          |        |            |        |          |        |            |        |          |  |  |        |          |        |          |
| 156125  | WTM 3063  |   |        |          |         |          |         |          |         |          |         |          |         |            |         |          |         |          |         |          |         |          |         |          |         |        |         |              |         |              |         |              |         |              |         |               |         |               |         |               |         |               |         |               |        |               |           |               |           |               |   |          |           |        |           |           |             |        |          |           |          |   |          |        |          |             |          |             |          |             |        |   |        |   |        |             |     |        |          |             |          |   |          |             |        |             |        |             |           |             |        |               |        |             |        |          |        |          |        |            |        |          |        |            |        |          |        |          |        |          |        |            |        |          |        |          |        |          |        |            |        |          |        |            |        |          |  |  |        |          |        |          |
|   |   |   |        |          |         |          |         |          |         |          |         |          |         |            |         |          |         |          |         |          |         |          |         |          |         |        |         |              |         |              |         |              |         |              |         |               |         |               |         |               |         |               |         |               |        |               |           |               |           |               |   |          |           |        |           |           |             |        |          |           |          |   |          |        |          |             |          |             |          |             |        |   |        |   |        |             |     |        |          |             |          |   |          |             |        |             |        |             |           |             |        |               |        |             |        |          |        |          |        |            |        |          |        |            |        |          |        |          |        |          |        |            |        |          |        |          |        |          |        |            |        |          |        |            |        |          |  |  |        |          |        |          |
| 155123  | WTM 2071  |   |        |          |         |          |         |          |         |          |         |          |         |            |         |          |         |          |         |          |         |          |         |          |         |        |         |              |         |              |         |              |         |              |         |               |         |               |         |               |         |               |         |               |        |               |           |               |           |               |   |          |           |        |           |           |             |        |          |           |          |   |          |        |          |             |          |             |          |             |        |   |        |   |        |             |     |        |          |             |          |   |          |             |        |             |        |             |           |             |        |               |        |             |        |          |        |          |        |            |        |          |        |            |        |          |        |          |        |          |        |            |        |          |        |          |        |          |        |            |        |          |        |            |        |          |  |  |        |          |        |          |
| 156123  | WTM 2072  |   |        |          |         |          |         |          |         |          |         |          |         |            |         |          |         |          |         |          |         |          |         |          |         |        |         |              |         |              |         |              |         |              |         |               |         |               |         |               |         |               |         |               |        |               |           |               |           |               |   |          |           |        |           |           |             |        |          |           |          |   |          |        |          |             |          |             |          |             |        |   |        |   |        |             |     |        |          |             |          |   |          |             |        |             |        |             |           |             |        |               |        |             |        |          |        |          |        |            |        |          |        |            |        |          |        |          |        |          |        |            |        |          |        |          |        |          |        |            |        |          |        |            |        |          |  |  |        |          |        |          |
| <p><b>Grundwerkzeughalter für Seitenschlitten<br/>Schütte - Nutenstein starr und schwenkbar</b></p>    | <p><b>Werkzeugträger, Werkzeugträgerrohlinge<br/>und Wechselhalter</b></p>  <table border="1"> <thead> <tr> <th>Art.-Nr.</th> <th>Typ</th> </tr> </thead> <tbody> <tr><td>112123</td><td>WT 2030</td></tr> <tr><td>113123</td><td>WT 2035</td></tr> <tr><td>101125</td><td>WT 3030</td></tr> <tr><td>102125</td><td>WT 3031</td></tr> <tr><td>103125</td><td>WT 3032</td></tr> <tr><td>104125</td><td>WT 3035</td></tr> <tr><td>105125</td><td>WT 3036</td></tr> <tr><td>106125</td><td>WT 3037</td></tr> <tr><td>116123</td><td>WT 2050</td></tr> <tr><td>117123</td><td>WT 2051</td></tr> <tr><td>109125</td><td>WT 3050</td></tr> <tr><td>110125</td><td>WT 3051</td></tr> <tr><td>118123</td><td>WH 2050</td></tr> <tr><td>119123</td><td>WH 2051</td></tr> <tr><td>111125</td><td>WH 3050</td></tr> <tr><td>123123</td><td>WH 2053</td></tr> <tr><td>123125</td><td>WH 3053</td></tr> <tr><td>135123</td><td>WH 2055</td></tr> <tr><td>136123</td><td>WH 2056</td></tr> <tr><td>126125</td><td>WH 3055</td></tr> <tr><td colspan="2"> </td></tr> <tr><td>115121</td><td>WT 1040-R</td></tr> <tr><td>114123</td><td>WT 2040-R</td></tr> <tr><td>115123</td><td>WT 2041-R</td></tr> <tr><td>107125</td><td>WT 3040-R</td></tr> <tr><td>108125</td><td>WT 3041-R</td></tr> <tr><td colspan="2"> </td></tr> <tr><td>140123</td><td></td></tr> <tr><td>140123-iK</td><td></td></tr> </tbody> </table> | Art.-Nr.  | Typ    | 112123   | WT 2030 | 113123   | WT 2035 | 101125   | WT 3030 | 102125   | WT 3031 | 103125   | WT 3032 | 104125     | WT 3035 | 105125   | WT 3036 | 106125   | WT 3037 | 116123   | WT 2050 | 117123   | WT 2051 | 109125   | WT 3050 | 110125 | WT 3051 | 118123       | WH 2050 | 119123       | WH 2051 | 111125       | WH 3050 | 123123       | WH 2053 | 123125        | WH 3053 | 135123        | WH 2055 | 136123        | WH 2056 | 126125        | WH 3055 |               |        | 115121        | WT 1040-R | 114123        | WT 2040-R | 115123        | WT 2041-R   | 107125   | WT 3040-R | 108125 | WT 3041-R |           |             | 140123 |          | 140123-iK |          | <p><b>Grundwerkzeughalter und Werkzeugträger<br/>mit innerer Kühlmittelzufuhr für Schütte<br/>incl. schwenkbarem Nutenstein</b></p>  <table border="1"> <thead> <tr> <th>Art.-Nr.</th> <th>Typ</th> </tr> </thead> <tbody> <tr><td>250122</td><td>ZWM 2240-iK</td></tr> <tr><td>246122</td><td>ZWM 2241-iK</td></tr> <tr><td>182124</td><td>ZWM 3240-iK</td></tr> <tr><td>183124</td><td>ZWM 3241-iK</td></tr> <tr><td>184124</td><td>ZWM 3230-iK</td></tr> <tr><td>185124</td><td>ZWM 3231-iK</td></tr> <tr><td colspan="2"> </td></tr> <tr><td>306123</td><td>WTM 2052-iK</td></tr> <tr><td>238125</td><td>WTM 3052-S-iK</td></tr> <tr><td>176125</td><td>WTM 3061-iK</td></tr> <tr><td>240125</td><td>WTM 3061-iK</td></tr> <tr><td>239125</td><td>WTM 3062-iK</td></tr> <tr><td>241125</td><td>WTM 3062-iK</td></tr> <tr><td>237125</td><td>WTM 3062-S-iK</td></tr> <tr><td>242125</td><td>WTM 3063-iK</td></tr> </tbody> </table> | Art.-Nr. | Typ    | 250122   | ZWM 2240-iK | 246122   | ZWM 2241-iK | 182124   | ZWM 3240-iK | 183124 | ZWM 3241-iK   | 184124 | ZWM 3230-iK   | 185124 | ZWM 3231-iK |     |        | 306123   | WTM 2052-iK | 238125   | WTM 3052-S-iK   | 176125   | WTM 3061-iK | 240125 | WTM 3061-iK | 239125 | WTM 3062-iK | 241125    | WTM 3062-iK | 237125 | WTM 3062-S-iK | 242125 | WTM 3063-iK |        |          |        |          |        |            |        |          |        |            |        |          |        |          |        |          |        |            |        |          |        |          |        |          |        |            |        |          |        |            |        |          |  |  |        |          |        |          |
| Art.-Nr.  | Typ   |   |        |          |         |          |         |          |         |          |         |          |         |            |         |          |         |          |         |          |         |          |         |          |         |        |         |              |         |              |         |              |         |              |         |               |         |               |         |               |         |               |         |               |        |               |           |               |           |               |   |          |           |        |           |           |             |        |          |           |          |   |          |        |          |             |          |             |          |             |        |   |        |   |        |             |     |        |          |             |          |   |          |             |        |             |        |             |           |             |        |               |        |             |        |          |        |          |        |            |        |          |        |            |        |          |        |          |        |          |        |            |        |          |        |          |        |          |        |            |        |          |        |            |        |          |  |  |        |          |        |          |
| 112123  | WT 2030   |   |        |          |         |          |         |          |         |          |         |          |         |            |         |          |         |          |         |          |         |          |         |          |         |        |         |              |         |              |         |              |         |              |         |               |         |               |         |               |         |               |         |               |        |               |           |               |           |               |   |          |           |        |           |           |             |        |          |           |          |   |          |        |          |             |          |             |          |             |        |   |        |   |        |             |     |        |          |             |          |   |          |             |        |             |        |             |           |             |        |               |        |             |        |          |        |          |        |            |        |          |        |            |        |          |        |          |        |          |        |            |        |          |        |          |        |          |        |            |        |          |        |            |        |          |  |  |        |          |        |          |
| 113123  | WT 2035   |   |        |          |         |          |         |          |         |          |         |          |         |            |         |          |         |          |         |          |         |          |         |          |         |        |         |              |         |              |         |              |         |              |         |               |         |               |         |               |         |               |         |               |        |               |           |               |           |               |   |          |           |        |           |           |             |        |          |           |          |   |          |        |          |             |          |             |          |             |        |   |        |   |        |             |     |        |          |             |          |   |          |             |        |             |        |             |           |             |        |               |        |             |        |          |        |          |        |            |        |          |        |            |        |          |        |          |        |          |        |            |        |          |        |          |        |          |        |            |        |          |        |            |        |          |  |  |        |          |        |          |
| 101125  | WT 3030   |   |        |          |         |          |         |          |         |          |         |          |         |            |         |          |         |          |         |          |         |          |         |          |         |        |         |              |         |              |         |              |         |              |         |               |         |               |         |               |         |               |         |               |        |               |           |               |           |               |   |          |           |        |           |           |             |        |          |           |          |   |          |        |          |             |          |             |          |             |        |   |        |   |        |             |     |        |          |             |          |   |          |             |        |             |        |             |           |             |        |               |        |             |        |          |        |          |        |            |        |          |        |            |        |          |        |          |        |          |        |            |        |          |        |          |        |          |        |            |        |          |        |            |        |          |  |  |        |          |        |          |
| 102125  | WT 3031   |   |        |          |         |          |         |          |         |          |         |          |         |            |         |          |         |          |         |          |         |          |         |          |         |        |         |              |         |              |         |              |         |              |         |               |         |               |         |               |         |               |         |               |        |               |           |               |           |               |   |          |           |        |           |           |             |        |          |           |          |   |          |        |          |             |          |             |          |             |        |   |        |   |        |             |     |        |          |             |          |   |          |             |        |             |        |             |           |             |        |               |        |             |        |          |        |          |        |            |        |          |        |            |        |          |        |          |        |          |        |            |        |          |        |          |        |          |        |            |        |          |        |            |        |          |  |  |        |          |        |          |
| 103125  | WT 3032   |   |        |          |         |          |         |          |         |          |         |          |         |            |         |          |         |          |         |          |         |          |         |          |         |        |         |              |         |              |         |              |         |              |         |               |         |               |         |               |         |               |         |               |        |               |           |               |           |               |   |          |           |        |           |           |             |        |          |           |          |   |          |        |          |             |          |             |          |             |        |   |        |   |        |             |     |        |          |             |          |   |          |             |        |             |        |             |           |             |        |               |        |             |        |          |        |          |        |            |        |          |        |            |        |          |        |          |        |          |        |            |        |          |        |          |        |          |        |            |        |          |        |            |        |          |  |  |        |          |        |          |
| 104125  | WT 3035   |   |        |          |         |          |         |          |         |          |         |          |         |            |         |          |         |          |         |          |         |          |         |          |         |        |         |              |         |              |         |              |         |              |         |               |         |               |         |               |         |               |         |               |        |               |           |               |           |               |   |          |           |        |           |           |             |        |          |           |          |   |          |        |          |             |          |             |          |             |        |   |        |   |        |             |     |        |          |             |          |   |          |             |        |             |        |             |           |             |        |               |        |             |        |          |        |          |        |            |        |          |        |            |        |          |        |          |        |          |        |            |        |          |        |          |        |          |        |            |        |          |        |            |        |          |  |  |        |          |        |          |
| 105125  | WT 3036   |   |        |          |         |          |         |          |         |          |         |          |         |            |         |          |         |          |         |          |         |          |         |          |         |        |         |              |         |              |         |              |         |              |         |               |         |               |         |               |         |               |         |               |        |               |           |               |           |               |   |          |           |        |           |           |             |        |          |           |          |   |          |        |          |             |          |             |          |             |        |   |        |   |        |             |     |        |          |             |          |   |          |             |        |             |        |             |           |             |        |               |        |             |        |          |        |          |        |            |        |          |        |            |        |          |        |          |        |          |        |            |        |          |        |          |        |          |        |            |        |          |        |            |        |          |  |  |        |          |        |          |
| 106125  | WT 3037   |   |        |          |         |          |         |          |         |          |         |          |         |            |         |          |         |          |         |          |         |          |         |          |         |        |         |              |         |              |         |              |         |              |         |               |         |               |         |               |         |               |         |               |        |               |           |               |           |               |   |          |           |        |           |           |             |        |          |           |          |   |          |        |          |             |          |             |          |             |        |   |        |   |        |             |     |        |          |             |          |   |          |             |        |             |        |             |           |             |        |               |        |             |        |          |        |          |        |            |        |          |        |            |        |          |        |          |        |          |        |            |        |          |        |          |        |          |        |            |        |          |        |            |        |          |  |  |        |          |        |          |
| 116123  | WT 2050   |   |        |          |         |          |         |          |         |          |         |          |         |            |         |          |         |          |         |          |         |          |         |          |         |        |         |              |         |              |         |              |         |              |         |               |         |               |         |               |         |               |         |               |        |               |           |               |           |               |   |          |           |        |           |           |             |        |          |           |          |   |          |        |          |             |          |             |          |             |        |   |        |   |        |             |     |        |          |             |          |   |          |             |        |             |        |             |           |             |        |               |        |             |        |          |        |          |        |            |        |          |        |            |        |          |        |          |        |          |        |            |        |          |        |          |        |          |        |            |        |          |        |            |        |          |  |  |        |          |        |          |
| 117123  | WT 2051   |   |        |          |         |          |         |          |         |          |         |          |         |            |         |          |         |          |         |          |         |          |         |          |         |        |         |              |         |              |         |              |         |              |         |               |         |               |         |               |         |               |         |               |        |               |           |               |           |               |   |          |           |        |           |           |             |        |          |           |          |   |          |        |          |             |          |             |          |             |        |   |        |   |        |             |     |        |          |             |          |   |          |             |        |             |        |             |           |             |        |               |        |             |        |          |        |          |        |            |        |          |        |            |        |          |        |          |        |          |        |            |        |          |        |          |        |          |        |            |        |          |        |            |        |          |  |  |        |          |        |          |
| 109125  | WT 3050   |   |        |          |         |          |         |          |         |          |         |          |         |            |         |          |         |          |         |          |         |          |         |          |         |        |         |              |         |              |         |              |         |              |         |               |         |               |         |               |         |               |         |               |        |               |           |               |           |               |   |          |           |        |           |           |             |        |          |           |          |   |          |        |          |             |          |             |          |             |        |   |        |   |        |             |     |        |          |             |          |   |          |             |        |             |        |             |           |             |        |               |        |             |        |          |        |          |        |            |        |          |        |            |        |          |        |          |        |          |        |            |        |          |        |          |        |          |        |            |        |          |        |            |        |          |  |  |        |          |        |          |
| 110125  | WT 3051   |   |        |          |         |          |         |          |         |          |         |          |         |            |         |          |         |          |         |          |         |          |         |          |         |        |         |              |         |              |         |              |         |              |         |               |         |               |         |               |         |               |         |               |        |               |           |               |           |               |   |          |           |        |           |           |             |        |          |           |          |   |          |        |          |             |          |             |          |             |        |   |        |   |        |             |     |        |          |             |          |   |          |             |        |             |        |             |           |             |        |               |        |             |        |          |        |          |        |            |        |          |        |            |        |          |        |          |        |          |        |            |        |          |        |          |        |          |        |            |        |          |        |            |        |          |  |  |        |          |        |          |
| 118123  | WH 2050   |   |        |          |         |          |         |          |         |          |         |          |         |            |         |          |         |          |         |          |         |          |         |          |         |        |         |              |         |              |         |              |         |              |         |               |         |               |         |               |         |               |         |               |        |               |           |               |           |               |   |          |           |        |           |           |             |        |          |           |          |   |          |        |          |             |          |             |          |             |        |   |        |   |        |             |     |        |          |             |          |   |          |             |        |             |        |             |           |             |        |               |        |             |        |          |        |          |        |            |        |          |        |            |        |          |        |          |        |          |        |            |        |          |        |          |        |          |        |            |        |          |        |            |        |          |  |  |        |          |        |          |
| 119123  | WH 2051   |   |        |          |         |          |         |          |         |          |         |          |         |            |         |          |         |          |         |          |         |          |         |          |         |        |         |              |         |              |         |              |         |              |         |               |         |               |         |               |         |               |         |               |        |               |           |               |           |               |   |          |           |        |           |           |             |        |          |           |          |   |          |        |          |             |          |             |          |             |        |   |        |   |        |             |     |        |          |             |          |   |          |             |        |             |        |             |           |             |        |               |        |             |        |          |        |          |        |            |        |          |        |            |        |          |        |          |        |          |        |            |        |          |        |          |        |          |        |            |        |          |        |            |        |          |  |  |        |          |        |          |
| 111125  | WH 3050   |   |        |          |         |          |         |          |         |          |         |          |         |            |         |          |         |          |         |          |         |          |         |          |         |        |         |              |         |              |         |              |         |              |         |               |         |               |         |               |         |               |         |               |        |               |           |               |           |               |   |          |           |        |           |           |             |        |          |           |          |   |          |        |          |             |          |             |          |             |        |   |        |   |        |             |     |        |          |             |          |   |          |             |        |             |        |             |           |             |        |               |        |             |        |          |        |          |        |            |        |          |        |            |        |          |        |          |        |          |        |            |        |          |        |          |        |          |        |            |        |          |        |            |        |          |  |  |        |          |        |          |
| 123123  | WH 2053   |   |        |          |         |          |         |          |         |          |         |          |         |            |         |          |         |          |         |          |         |          |         |          |         |        |         |              |         |              |         |              |         |              |         |               |         |               |         |               |         |               |         |               |        |               |           |               |           |               |   |          |           |        |           |           |             |        |          |           |          |   |          |        |          |             |          |             |          |             |        |   |        |   |        |             |     |        |          |             |          |   |          |             |        |             |        |             |           |             |        |               |        |             |        |          |        |          |        |            |        |          |        |            |        |          |        |          |        |          |        |            |        |          |        |          |        |          |        |            |        |          |        |            |        |          |  |  |        |          |        |          |
| 123125  | WH 3053   |   |        |          |         |          |         |          |         |          |         |          |         |            |         |          |         |          |         |          |         |          |         |          |         |        |         |              |         |              |         |              |         |              |         |               |         |               |         |               |         |               |         |               |        |               |           |               |           |               |   |          |           |        |           |           |             |        |          |           |          |   |          |        |          |             |          |             |          |             |        |   |        |   |        |             |     |        |          |             |          |   |          |             |        |             |        |             |           |             |        |               |        |             |        |          |        |          |        |            |        |          |        |            |        |          |        |          |        |          |        |            |        |          |        |          |        |          |        |            |        |          |        |            |        |          |  |  |        |          |        |          |
| 135123  | WH 2055   |   |        |          |         |          |         |          |         |          |         |          |         |            |         |          |         |          |         |          |         |          |         |          |         |        |         |              |         |              |         |              |         |              |         |               |         |               |         |               |         |               |         |               |        |               |           |               |           |               |   |          |           |        |           |           |             |        |          |           |          |   |          |        |          |             |          |             |          |             |        |   |        |   |        |             |     |        |          |             |          |   |          |             |        |             |        |             |           |             |        |               |        |             |        |          |        |          |        |            |        |          |        |            |        |          |        |          |        |          |        |            |        |          |        |          |        |          |        |            |        |          |        |            |        |          |  |  |        |          |        |          |
| 136123  | WH 2056   |   |        |          |         |          |         |          |         |          |         |          |         |            |         |          |         |          |         |          |         |          |         |          |         |        |         |              |         |              |         |              |         |              |         |               |         |               |         |               |         |               |         |               |        |               |           |               |           |               |   |          |           |        |           |           |             |        |          |           |          |   |          |        |          |             |          |             |          |             |        |   |        |   |        |             |     |        |          |             |          |   |          |             |        |             |        |             |           |             |        |               |        |             |        |          |        |          |        |            |        |          |        |            |        |          |        |          |        |          |        |            |        |          |        |          |        |          |        |            |        |          |        |            |        |          |  |  |        |          |        |          |
| 126125  | WH 3055   |   |        |          |         |          |         |          |         |          |         |          |         |            |         |          |         |          |         |          |         |          |         |          |         |        |         |              |         |              |         |              |         |              |         |               |         |               |         |               |         |               |         |               |        |               |           |               |           |               |   |          |           |        |           |           |             |        |          |           |          |   |          |        |          |             |          |             |          |             |        |   |        |   |        |             |     |        |          |             |          |   |          |             |        |             |        |             |           |             |        |               |        |             |        |          |        |          |        |            |        |          |        |            |        |          |        |          |        |          |        |            |        |          |        |          |        |          |        |            |        |          |        |            |        |          |  |  |        |          |        |          |
|   |   |   |        |          |         |          |         |          |         |          |         |          |         |            |         |          |         |          |         |          |         |          |         |          |         |        |         |              |         |              |         |              |         |              |         |               |         |               |         |               |         |               |         |               |        |               |           |               |           |               |   |          |           |        |           |           |             |        |          |           |          |   |          |        |          |             |          |             |          |             |        |   |        |   |        |             |     |        |          |             |          |   |          |             |        |             |        |             |           |             |        |               |        |             |        |          |        |          |        |            |        |          |        |            |        |          |        |          |        |          |        |            |        |          |        |          |        |          |        |            |        |          |        |            |        |          |  |  |        |          |        |          |
| 115121  | WT 1040-R   |   |        |          |         |          |         |          |         |          |         |          |         |            |         |          |         |          |         |          |         |          |         |          |         |        |         |              |         |              |         |              |         |              |         |               |         |               |         |               |         |               |         |               |        |               |           |               |           |               |   |          |           |        |           |           |             |        |          |           |          |   |          |        |          |             |          |             |          |             |        |   |        |   |        |             |     |        |          |             |          |   |          |             |        |             |        |             |           |             |        |               |        |             |        |          |        |          |        |            |        |          |        |            |        |          |        |          |        |          |        |            |        |          |        |          |        |          |        |            |        |          |        |            |        |          |  |  |        |          |        |          |
| 114123  | WT 2040-R   |   |        |          |         |          |         |          |         |          |         |          |         |            |         |          |         |          |         |          |         |          |         |          |         |        |         |              |         |              |         |              |         |              |         |               |         |               |         |               |         |               |         |               |        |               |           |               |           |               |   |          |           |        |           |           |             |        |          |           |          |   |          |        |          |             |          |             |          |             |        |   |        |   |        |             |     |        |          |             |          |   |          |             |        |             |        |             |           |             |        |               |        |             |        |          |        |          |        |            |        |          |        |            |        |          |        |          |        |          |        |            |        |          |        |          |        |          |        |            |        |          |        |            |        |          |  |  |        |          |        |          |
| 115123  | WT 2041-R   |   |        |          |         |          |         |          |         |          |         |          |         |            |         |          |         |          |         |          |         |          |         |          |         |        |         |              |         |              |         |              |         |              |         |               |         |               |         |               |         |               |         |               |        |               |           |               |           |               |   |          |           |        |           |           |             |        |          |           |          |   |          |        |          |             |          |             |          |             |        |   |        |   |        |             |     |        |          |             |          |   |          |             |        |             |        |             |           |             |        |               |        |             |        |          |        |          |        |            |        |          |        |            |        |          |        |          |        |          |        |            |        |          |        |          |        |          |        |            |        |          |        |            |        |          |  |  |        |          |        |          |
| 107125  | WT 3040-R   |   |        |          |         |          |         |          |         |          |         |          |         |            |         |          |         |          |         |          |         |          |         |          |         |        |         |              |         |              |         |              |         |              |         |               |         |               |         |               |         |               |         |               |        |               |           |               |           |               |   |          |           |        |           |           |             |        |          |           |          |   |          |        |          |             |          |             |          |             |        |   |        |   |        |             |     |        |          |             |          |   |          |             |        |             |        |             |           |             |        |               |        |             |        |          |        |          |        |            |        |          |        |            |        |          |        |          |        |          |        |            |        |          |        |          |        |          |        |            |        |          |        |            |        |          |  |  |        |          |        |          |
| 108125  | WT 3041-R   |   |        |          |         |          |         |          |         |          |         |          |         |            |         |          |         |          |         |          |         |          |         |          |         |        |         |              |         |              |         |              |         |              |         |               |         |               |         |               |         |               |         |               |        |               |           |               |           |               |   |          |           |        |           |           |             |        |          |           |          |   |          |        |          |             |          |             |          |             |        |   |        |   |        |             |     |        |          |             |          |   |          |             |        |             |        |             |           |             |        |               |        |             |        |          |        |          |        |            |        |          |        |            |        |          |        |          |        |          |        |            |        |          |        |          |        |          |        |            |        |          |        |            |        |          |  |  |        |          |        |          |
|   |   |   |        |          |         |          |         |          |         |          |         |          |         |            |         |          |         |          |         |          |         |          |         |          |         |        |         |              |         |              |         |              |         |              |         |               |         |               |         |               |         |               |         |               |        |               |           |               |           |               |   |          |           |        |           |           |             |        |          |           |          |   |          |        |          |             |          |             |          |             |        |   |        |   |        |             |     |        |          |             |          |   |          |             |        |             |        |             |           |             |        |               |        |             |        |          |        |          |        |            |        |          |        |            |        |          |        |          |        |          |        |            |        |          |        |          |        |          |        |            |        |          |        |            |        |          |  |  |        |          |        |          |
| 140123  |   |   |        |          |         |          |         |          |         |          |         |          |         |            |         |          |         |          |         |          |         |          |         |          |         |        |         |              |         |              |         |              |         |              |         |               |         |               |         |               |         |               |         |               |        |               |           |               |           |               |   |          |           |        |           |           |             |        |          |           |          |   |          |        |          |             |          |             |          |             |        |   |        |   |        |             |     |        |          |             |          |   |          |             |        |             |        |             |           |             |        |               |        |             |        |          |        |          |        |            |        |          |        |            |        |          |        |          |        |          |        |            |        |          |        |          |        |          |        |            |        |          |        |            |        |          |  |  |        |          |        |          |
| 140123-iK   |   |   |        |          |         |          |         |          |         |          |         |          |         |            |         |          |         |          |         |          |         |          |         |          |         |        |         |              |         |              |         |              |         |              |         |               |         |               |         |               |         |               |         |               |        |               |           |               |           |               |   |          |           |        |           |           |             |        |          |           |          |   |          |        |          |             |          |             |          |             |        |   |        |   |        |             |     |        |          |             |          |   |          |             |        |             |        |             |           |             |        |               |        |             |        |          |        |          |        |            |        |          |        |            |        |          |        |          |        |          |        |            |        |          |        |          |        |          |        |            |        |          |        |            |        |          |  |  |        |          |        |          |
| Art.-Nr.  | Typ   |   |        |          |         |          |         |          |         |          |         |          |         |            |         |          |         |          |         |          |         |          |         |          |         |        |         |              |         |              |         |              |         |              |         |               |         |               |         |               |         |               |         |               |        |               |           |               |           |               |   |          |           |        |           |           |             |        |          |           |          |   |          |        |          |             |          |             |          |             |        |   |        |   |        |             |     |        |          |             |          |   |          |             |        |             |        |             |           |             |        |               |        |             |        |          |        |          |        |            |        |          |        |            |        |          |        |          |        |          |        |            |        |          |        |          |        |          |        |            |        |          |        |            |        |          |  |  |        |          |        |          |
| 250122  | ZWM 2240-iK   |   |        |          |         |          |         |          |         |          |         |          |         |            |         |          |         |          |         |          |         |          |         |          |         |        |         |              |         |              |         |              |         |              |         |               |         |               |         |               |         |               |         |               |        |               |           |               |           |               |   |          |           |        |           |           |             |        |          |           |          |   |          |        |          |             |          |             |          |             |        |   |        |   |        |             |     |        |          |             |          |   |          |             |        |             |        |             |           |             |        |               |        |             |        |          |        |          |        |            |        |          |        |            |        |          |        |          |        |          |        |            |        |          |        |          |        |          |        |            |        |          |        |            |        |          |  |  |        |          |        |          |
| 246122  | ZWM 2241-iK   |   |        |          |         |          |         |          |         |          |         |          |         |            |         |          |         |          |         |          |         |          |         |          |         |        |         |              |         |              |         |              |         |              |         |               |         |               |         |               |         |               |         |               |        |               |           |               |           |               |   |          |           |        |           |           |             |        |          |           |          |   |          |        |          |             |          |             |          |             |        |   |        |   |        |             |     |        |          |             |          |   |          |             |        |             |        |             |           |             |        |               |        |             |        |          |        |          |        |            |        |          |        |            |        |          |        |          |        |          |        |            |        |          |        |          |        |          |        |            |        |          |        |            |        |          |  |  |        |          |        |          |
| 182124  | ZWM 3240-iK   |   |        |          |         |          |         |          |         |          |         |          |         |            |         |          |         |          |         |          |         |          |         |          |         |        |         |              |         |              |         |              |         |              |         |               |         |               |         |               |         |               |         |               |        |               |           |               |           |               |   |          |           |        |           |           |             |        |          |           |          |   |          |        |          |             |          |             |          |             |        |   |        |   |        |             |     |        |          |             |          |   |          |             |        |             |        |             |           |             |        |               |        |             |        |          |        |          |        |            |        |          |        |            |        |          |        |          |        |          |        |            |        |          |        |          |        |          |        |            |        |          |        |            |        |          |  |  |        |          |        |          |
| 183124  | ZWM 3241-iK   |   |        |          |         |          |         |          |         |          |         |          |         |            |         |          |         |          |         |          |         |          |         |          |         |        |         |              |         |              |         |              |         |              |         |               |         |               |         |               |         |               |         |               |        |               |           |               |           |               |   |          |           |        |           |           |             |        |          |           |          |   |          |        |          |             |          |             |          |             |        |   |        |   |        |             |     |        |          |             |          |   |          |             |        |             |        |             |           |             |        |               |        |             |        |          |        |          |        |            |        |          |        |            |        |          |        |          |        |          |        |            |        |          |        |          |        |          |        |            |        |          |        |            |        |          |  |  |        |          |        |          |
| 184124  | ZWM 3230-iK   |   |        |          |         |          |         |          |         |          |         |          |         |            |         |          |         |          |         |          |         |          |         |          |         |        |         |              |         |              |         |              |         |              |         |               |         |               |         |               |         |               |         |               |        |               |           |               |           |               |   |          |           |        |           |           |             |        |          |           |          |   |          |        |          |             |          |             |          |             |        |   |        |   |        |             |     |        |          |             |          |   |          |             |        |             |        |             |           |             |        |               |        |             |        |          |        |          |        |            |        |          |        |            |        |          |        |          |        |          |        |            |        |          |        |          |        |          |        |            |        |          |        |            |        |          |  |  |        |          |        |          |
| 185124  | ZWM 3231-iK   |   |        |          |         |          |         |          |         |          |         |          |         |            |         |          |         |          |         |          |         |          |         |          |         |        |         |              |         |              |         |              |         |              |         |               |         |               |         |               |         |               |         |               |        |               |           |               |           |               |   |          |           |        |           |           |             |        |          |           |          |   |          |        |          |             |          |             |          |             |        |   |        |   |        |             |     |        |          |             |          |   |          |             |        |             |        |             |           |             |        |               |        |             |        |          |        |          |        |            |        |          |        |            |        |          |        |          |        |          |        |            |        |          |        |          |        |          |        |            |        |          |        |            |        |          |  |  |        |          |        |          |
|   |   |   |        |          |         |          |         |          |         |          |         |          |         |            |         |          |         |          |         |          |         |          |         |          |         |        |         |              |         |              |         |              |         |              |         |               |         |               |         |               |         |               |         |               |        |               |           |               |           |               |   |          |           |        |           |           |             |        |          |           |          |   |          |        |          |             |          |             |          |             |        |   |        |   |        |             |     |        |          |             |          |   |          |             |        |             |        |             |           |             |        |               |        |             |        |          |        |          |        |            |        |          |        |            |        |          |        |          |        |          |        |            |        |          |        |          |        |          |        |            |        |          |        |            |        |          |  |  |        |          |        |          |
| 306123  | WTM 2052-iK   |   |        |          |         |          |         |          |         |          |         |          |         |            |         |          |         |          |         |          |         |          |         |          |         |        |         |              |         |              |         |              |         |              |         |               |         |               |         |               |         |               |         |               |        |               |           |               |           |               |   |          |           |        |           |           |             |        |          |           |          |   |          |        |          |             |          |             |          |             |        |   |        |   |        |             |     |        |          |             |          |   |          |             |        |             |        |             |           |             |        |               |        |             |        |          |        |          |        |            |        |          |        |            |        |          |        |          |        |          |        |            |        |          |        |          |        |          |        |            |        |          |        |            |        |          |  |  |        |          |        |          |
| 238125  | WTM 3052-S-iK   |   |        |          |         |          |         |          |         |          |         |          |         |            |         |          |         |          |         |          |         |          |         |          |         |        |         |              |         |              |         |              |         |              |         |               |         |               |         |               |         |               |         |               |        |               |           |               |           |               |   |          |           |        |           |           |             |        |          |           |          |   |          |        |          |             |          |             |          |             |        |   |        |   |        |             |     |        |          |             |          |   |          |             |        |             |        |             |           |             |        |               |        |             |        |          |        |          |        |            |        |          |        |            |        |          |        |          |        |          |        |            |        |          |        |          |        |          |        |            |        |          |        |            |        |          |  |  |        |          |        |          |
| 176125  | WTM 3061-iK   |   |        |          |         |          |         |          |         |          |         |          |         |            |         |          |         |          |         |          |         |          |         |          |         |        |         |              |         |              |         |              |         |              |         |               |         |               |         |               |         |               |         |               |        |               |           |               |           |               |   |          |           |        |           |           |             |        |          |           |          |   |          |        |          |             |          |             |          |             |        |   |        |   |        |             |     |        |          |             |          |   |          |             |        |             |        |             |           |             |        |               |        |             |        |          |        |          |        |            |        |          |        |            |        |          |        |          |        |          |        |            |        |          |        |          |        |          |        |            |        |          |        |            |        |          |  |  |        |          |        |          |
| 240125  | WTM 3061-iK   |   |        |          |         |          |         |          |         |          |         |          |         |            |         |          |         |          |         |          |         |          |         |          |         |        |         |              |         |              |         |              |         |              |         |               |         |               |         |               |         |               |         |               |        |               |           |               |           |               |   |          |           |        |           |           |             |        |          |           |          |   |          |        |          |             |          |             |          |             |        |   |        |   |        |             |     |        |          |             |          |   |          |             |        |             |        |             |           |             |        |               |        |             |        |          |        |          |        |            |        |          |        |            |        |          |        |          |        |          |        |            |        |          |        |          |        |          |        |            |        |          |        |            |        |          |  |  |        |          |        |          |
| 239125  | WTM 3062-iK   |   |        |          |         |          |         |          |         |          |         |          |         |            |         |          |         |          |         |          |         |          |         |          |         |        |         |              |         |              |         |              |         |              |         |               |         |               |         |               |         |               |         |               |        |               |           |               |           |               |   |          |           |        |           |           |             |        |          |           |          |   |          |        |          |             |          |             |          |             |        |   |        |   |        |             |     |        |          |             |          |   |          |             |        |             |        |             |           |             |        |               |        |             |        |          |        |          |        |            |        |          |        |            |        |          |        |          |        |          |        |            |        |          |        |          |        |          |        |            |        |          |        |            |        |          |  |  |        |          |        |          |
| 241125  | WTM 3062-iK   |   |        |          |         |          |         |          |         |          |         |          |         |            |         |          |         |          |         |          |         |          |         |          |         |        |         |              |         |              |         |              |         |              |         |               |         |               |         |               |         |               |         |               |        |               |           |               |           |               |   |          |           |        |           |           |             |        |          |           |          |   |          |        |          |             |          |             |          |             |        |   |        |   |        |             |     |        |          |             |          |   |          |             |        |             |        |             |           |             |        |               |        |             |        |          |        |          |        |            |        |          |        |            |        |          |        |          |        |          |        |            |        |          |        |          |        |          |        |            |        |          |        |            |        |          |  |  |        |          |        |          |
| 237125  | WTM 3062-S-iK   |   |        |          |         |          |         |          |         |          |         |          |         |            |         |          |         |          |         |          |         |          |         |          |         |        |         |              |         |              |         |              |         |              |         |               |         |               |         |               |         |               |         |               |        |               |           |               |           |               |   |          |           |        |           |           |             |        |          |           |          |   |          |        |          |             |          |             |          |             |        |   |        |   |        |             |     |        |          |             |          |   |          |             |        |             |        |             |           |             |        |               |        |             |        |          |        |          |        |            |        |          |        |            |        |          |        |          |        |          |        |            |        |          |        |          |        |          |        |            |        |          |        |            |        |          |  |  |        |          |        |          |
| 242125  | WTM 3063-iK   |   |        |          |         |          |         |          |         |          |         |          |         |            |         |          |         |          |         |          |         |          |         |          |         |        |         |              |         |              |         |              |         |              |         |               |         |               |         |               |         |               |         |               |        |               |           |               |           |               |   |          |           |        |           |           |             |        |          |           |          |   |          |        |          |             |          |             |          |             |        |   |        |   |        |             |     |        |          |             |          |   |          |             |        |             |        |             |           |             |        |               |        |             |        |          |        |          |        |            |        |          |        |            |        |          |        |          |        |          |        |            |        |          |        |          |        |          |        |            |        |          |        |            |        |          |  |  |        |          |        |          |

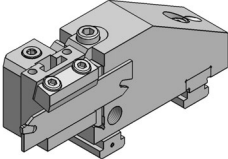
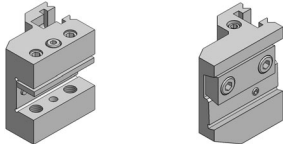
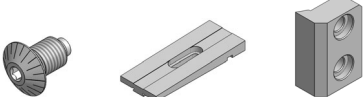
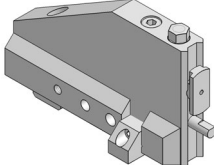
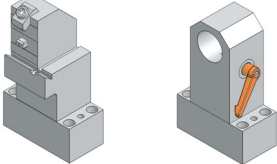
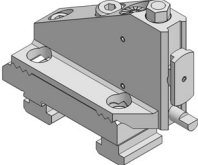

| Grundwerkzeughalter und Werkzeugträger zum Abstecken für Gildemeister + Schütte   |             | Wechselhalter schmale Ausführung  |             | Ersatzteile   |          |        |          |
|---|-------------|---|-------------|---|----------|--------|----------|
|    |             |    |             |  |          |        |          |
| Art.-Nr.  | Typ         | Art.-Nr.  | Typ         | Art.-Nr.  | Typ      |        |          |
| 187122  | ZWM 2031-A  | 101129  | WH 1050     | 192101  | P 1000   |        |          |
| 163124  | ZWM 3031-A  | 102129  | WH 1051     | 193101  | P 2000   |        |          |
| 164124  | ZWM 3032-A  | 103129  | WH 1016-R0° | 194101  | P 2001   |        |          |
| 188122  | ZWM 2231-A  | 104129  | WH 1016-L0° | 195101  | P 3000   |        |          |
| 165124  | ZWM 3231-A  | 105129  | WH 1017-R   | 205101  | P 2050   |        |          |
| 157123  | WTM 2050-A  | 106129  | WH 1017-L   | 206101  | P 2051   |        |          |
| 158123  | WTM 2051-A  | 107129  | WH 1026-R   | 207101  | P 2052   |        |          |
| 141125  | WTM 3050-A  | 108129  | WH 1026-L   | 208101  | P 3050   |        |          |
| 142125  | WTM 3051-A  | 109129  | WH 1020-RA  | 209101  | P 3051   |        |          |
| <b>Grundwerkzeughalter für Seitenschlitten schmale Ausführung</b><br> |             | 110129  | WH 1016-RA  | 210101  | P 3051-S |        |          |
|   |             | 111129  | WH 1020-RA  | 211101  | P 3052   |        |          |
|   |             | 113129  | WH 1020-LA  | 212101  | P 3052-S |        |          |
|   |             | 114129  | WH 1016-LA  | 213101  | P 3053   |        |          |
|   |             | 115129  | WH 1020-LA  | 214101  | P 2060   |        |          |
|   |             | 117129  | WH 1020-R   | 215101  | P 2061   |        |          |
|   |             | 118129  | WH 1020-L   | 216101  | P 2062   |        |          |
|   |             | 119129  | WH 1020-R   | 217101  | P 3060   |        |          |
|   |             | 120129  | WH 1020-L   | 218101  | P 3061   |        |          |
|   |             | 121129  | WH 1026-RA  | 219101  | P 3061-S |        |          |
|   |             | 122129  | WH 1026-LA  | 220101  | P 3062   |        |          |
|   |             | 123129  | WH 1017-RA  | 221101  | P 3062-S |        |          |
|   |             | 124129  | WH 1017-LA  | 222101  | P 3063   |        |          |
|   |             | <b>Adapter für Voreinstellung incl. Nulllehre</b><br>                      |             | 196101  | SP 2000  | 198101 | EX 2000  |
|   |             |   |             | 197101  | SP 3000  | 199101 | EX 3000  |
|   |             |   |             | 231101  | SP 101   | 232101 | EX 101   |
|   |             |   |             | 200101  | AN 10    | 201101 | AN 20    |
|   |             |   |             | 201101  | AN 20    | 230101 | AN 20/30 |
|   |             | <b>Grundwerkzeughalter für Seitenschlitten mit Maßkorrektur ± 0,25</b><br> |             | 130100  | FS 10    | 133100 | FS 20    |
|   |             |   |             | 202101  | EP 14    | 203101 | EP 13    |
| 204101  | EP 20       |   |             | 223101  | VK 2020  |        |          |
| 224101  | VK 2028     |   |             | 225101  | VK 2040  |        |          |
| 226101  | VK 3020     |   |             | 227101  | VK 3028  |        |          |
| 228101  | VK 3040     |   |             | 229101  | VK 3050  |        |          |
| 136100  | Anschlag ø6 |   |             | 171100  | Schraube |        |          |
| 250130  | AZWM 1000-1 |   |             |   |          |        |          |
| 251130  | AZWM 1000-2 |   |             |   |          |        |          |
| 252130  | AZWM 2000-1 |   |             |   |          |        |          |
| 253130  | AZWM 2000-2 |   |             |   |          |        |          |
| 254130  | AZWM 3000-1 |   |             |   |          |        |          |
| 255130  | AZWM 3000-2 |   |             |   |          |        |          |
| 282130  | AZWM 101-1  |   |             |   |          |        |          |
| 283130  | AZWM 101-2  |   |             |   |          |        |          |
| 256130  | AZWM 7040-1 |   |             |   |          |        |          |
| 257130  | AZWM 7040-2 |   |             |   |          |        |          |
| 258130  | AZWM 7050-1 |   |             |   |          |        |          |
| 259130  | AZWM 7050-2 |   |             |   |          |        |          |
| 297130  | ø28x172     |   |             |   |          |        |          |
| 298130  | ø36x172     |   |             |   |          |        |          |
| 301130  | ø28+1"x172  |   |             |   |          |        |          |
| 303130  | Sph.140     |   |             |   |          |        |          |
| 304130  | Sph.172     |   |             |   |          |        |          |